

COLLEGAMENTI X
P 38

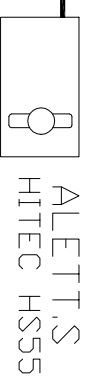

STERZO
HITEC HS55

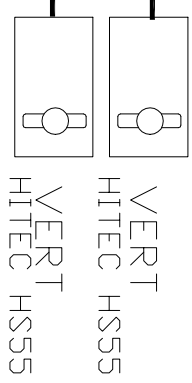
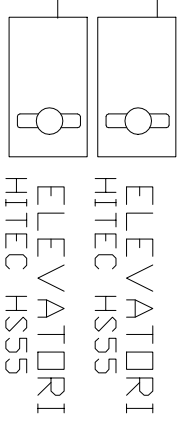
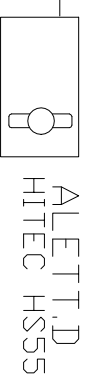
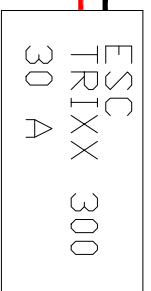
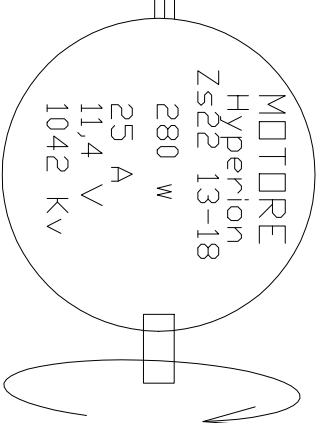
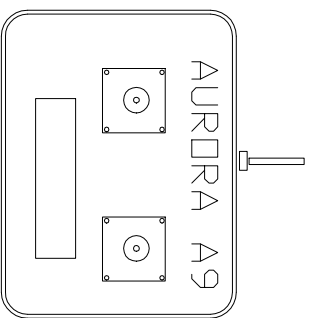
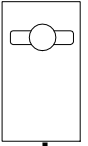

CARRELLI
int. ON/OFF
HITEC HS55

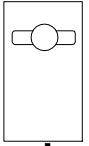

CARRELLI
int. ON/OFF
HITEC HS55

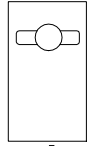

CARRELLI
int. ON/OFF
HITEC HS55

