

(1, 1)

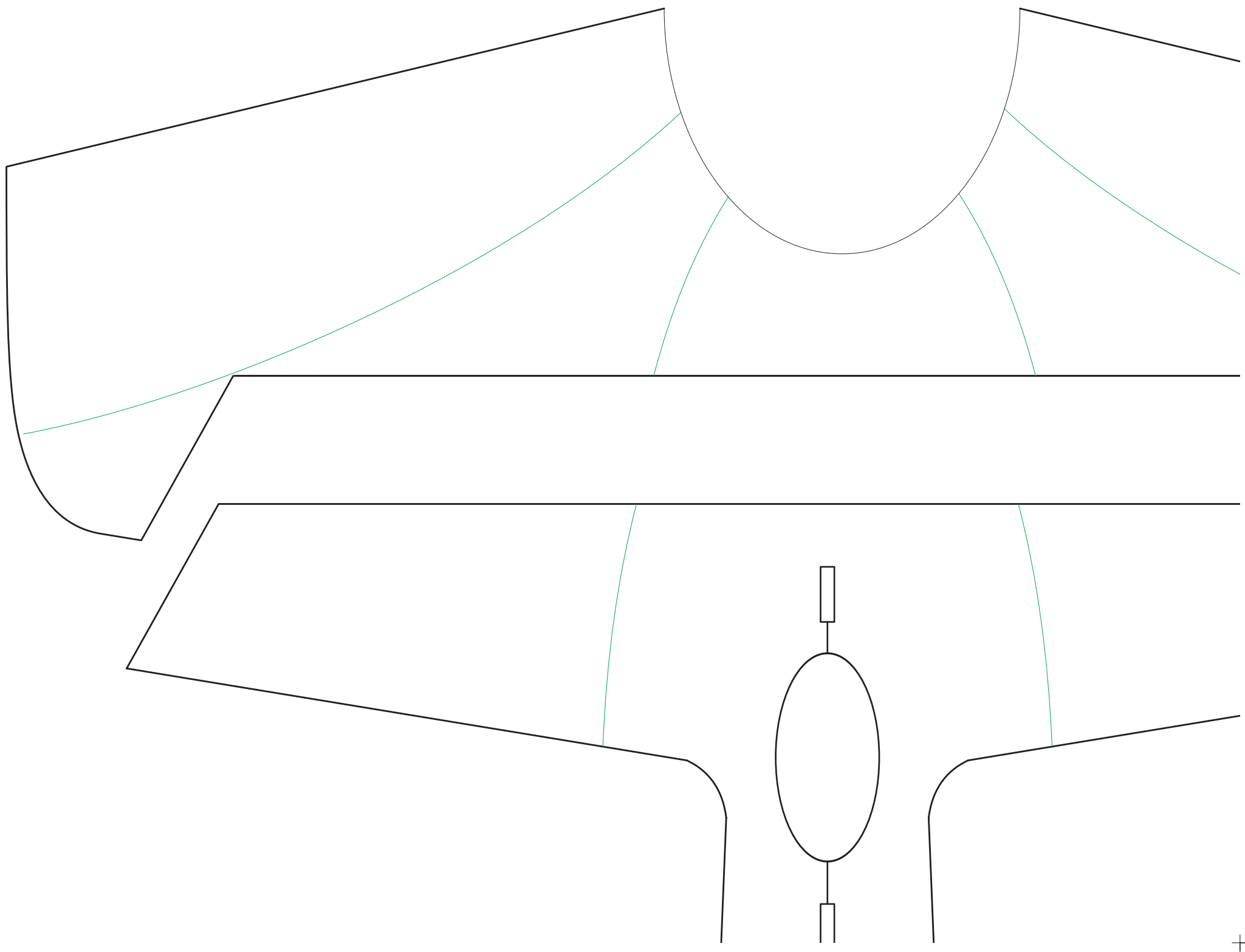

(2, 1)

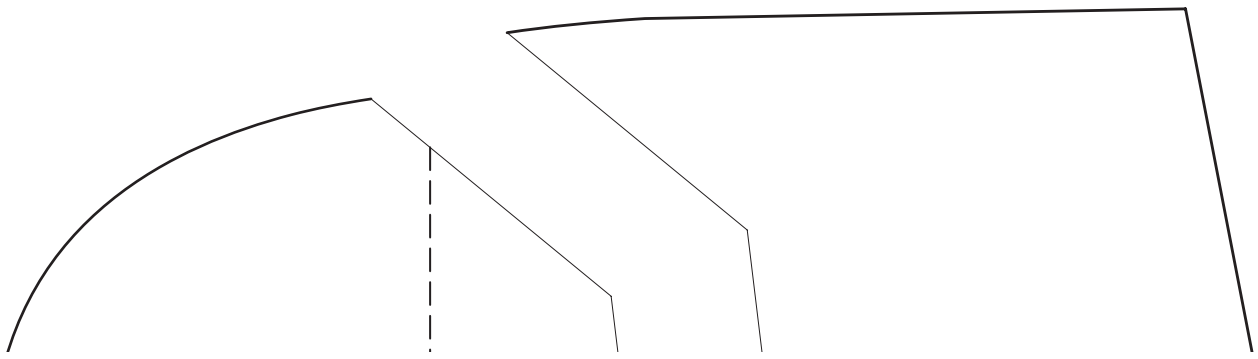
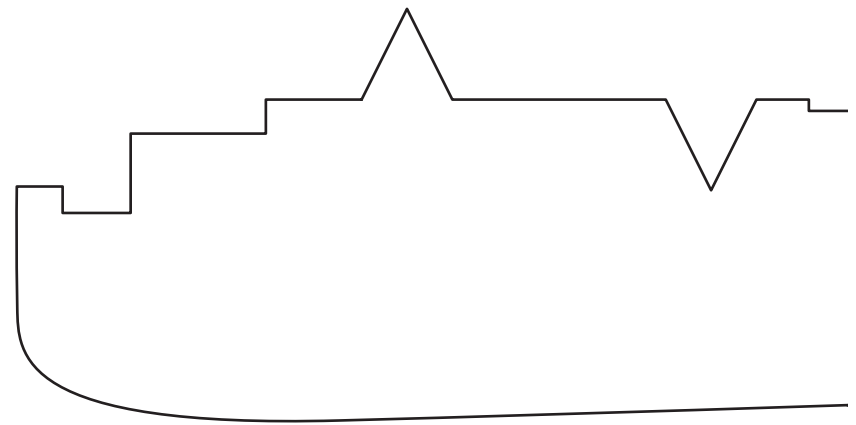
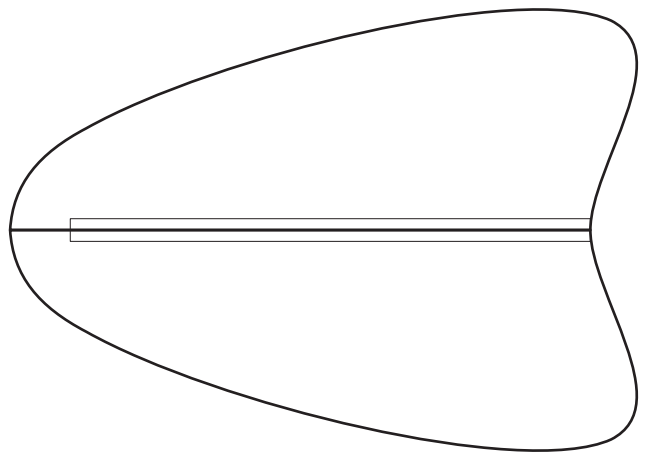
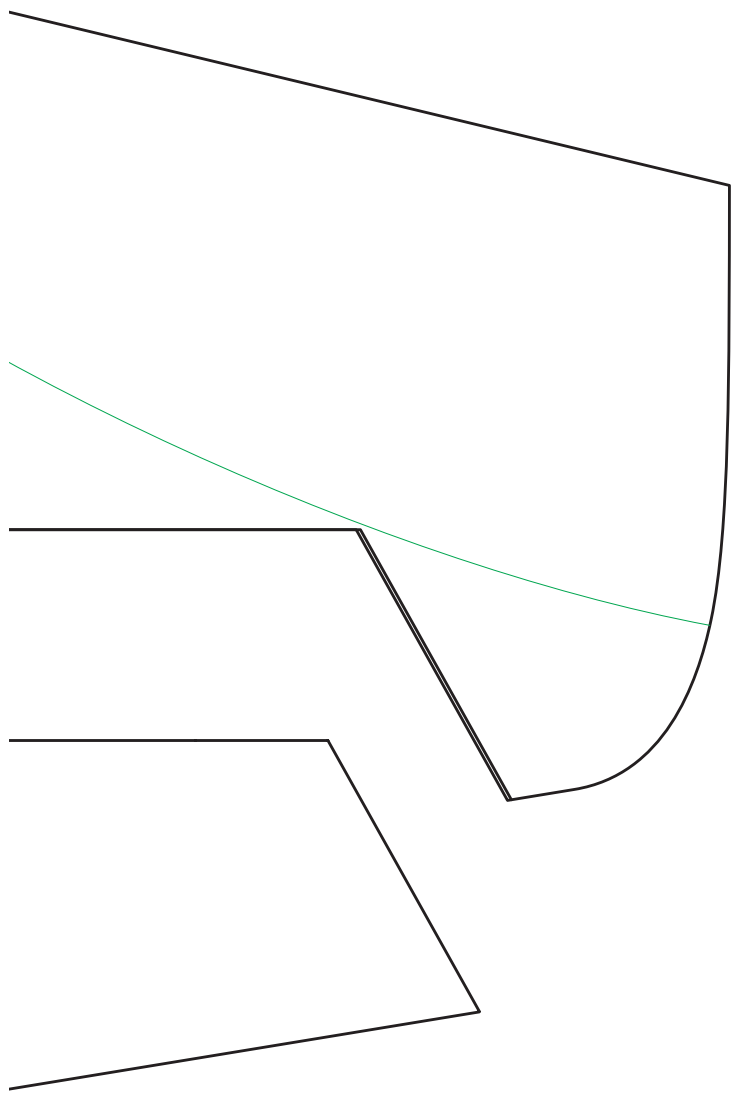

(3, 1)

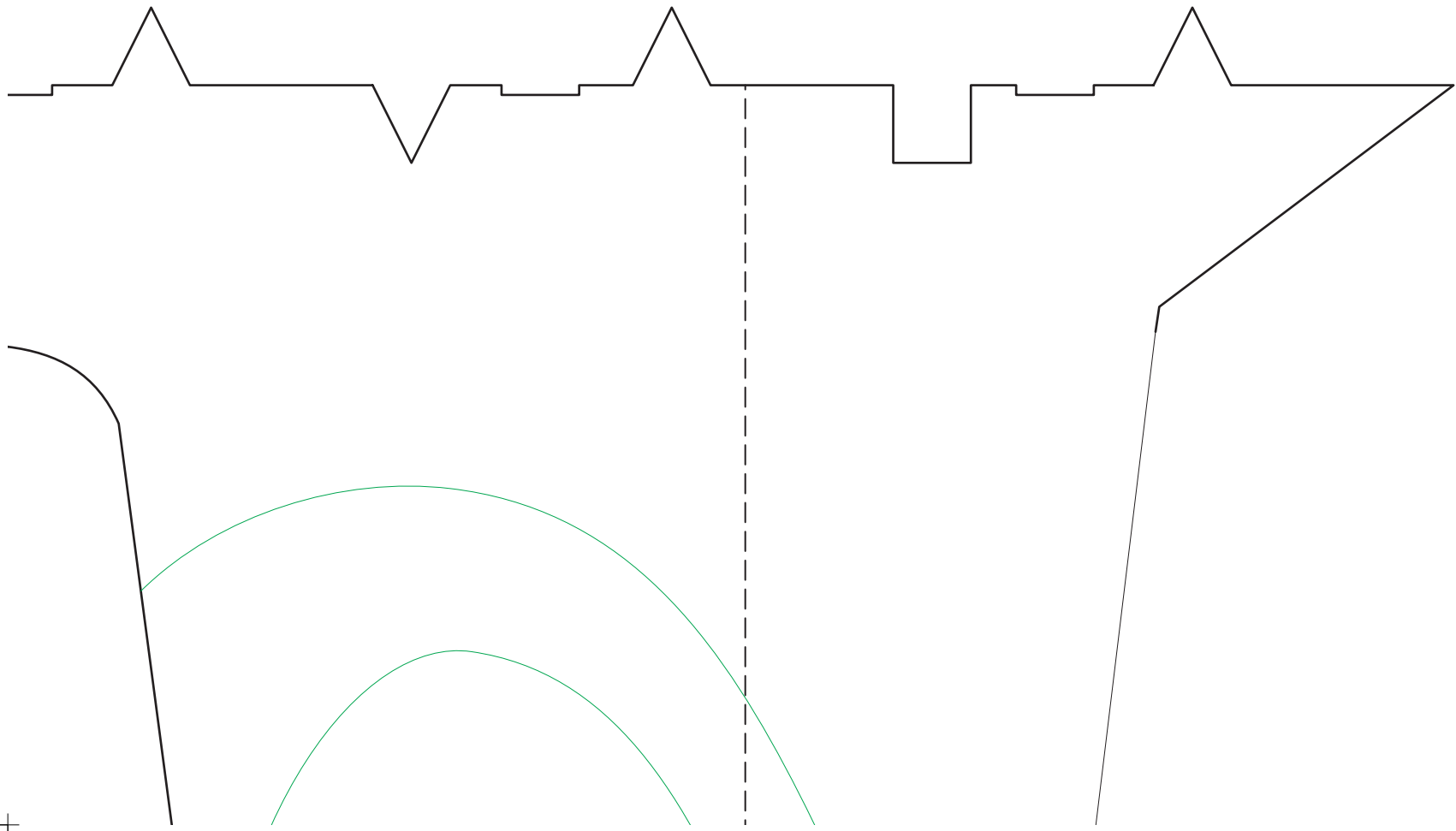

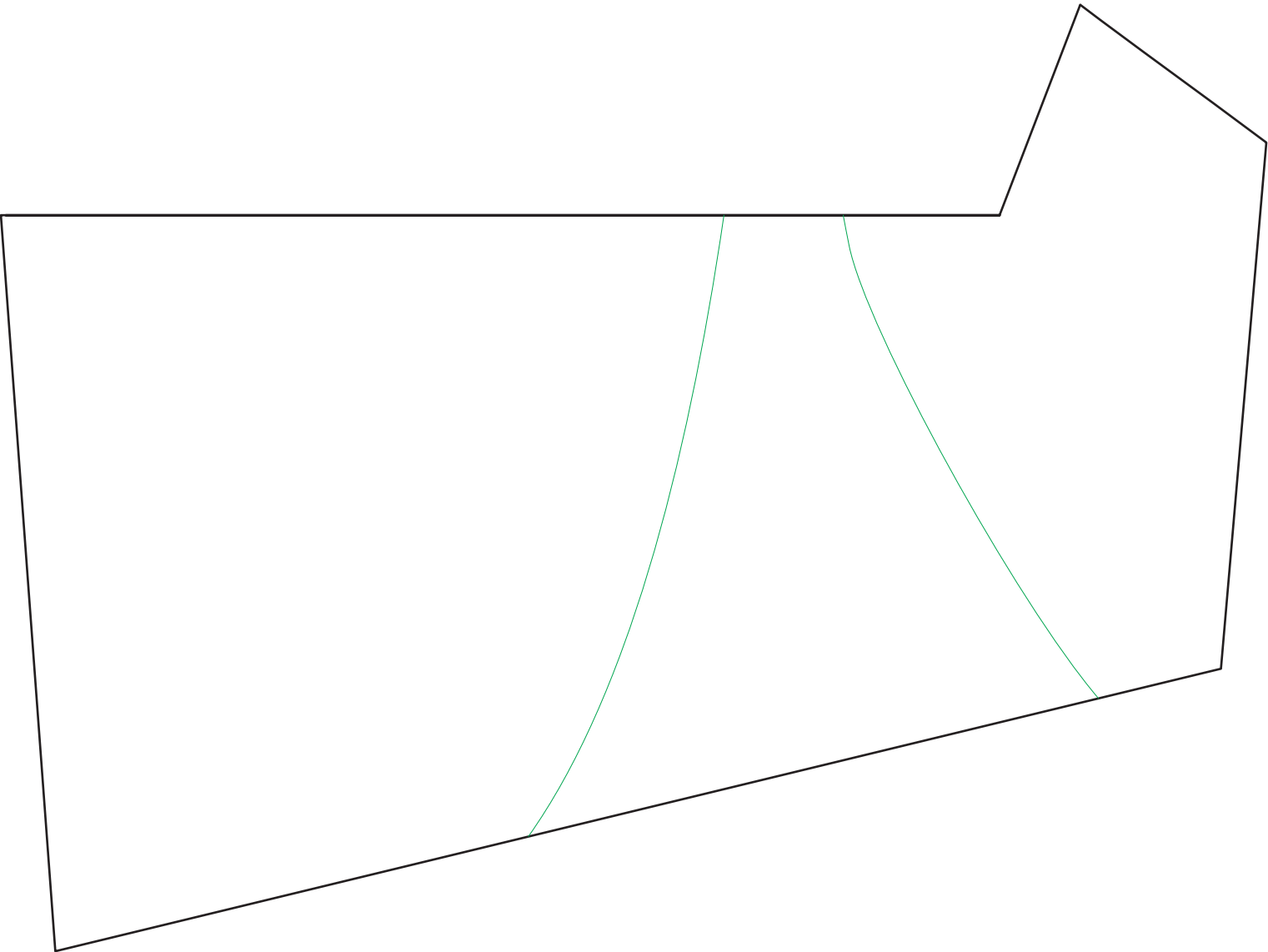

template for drag holes

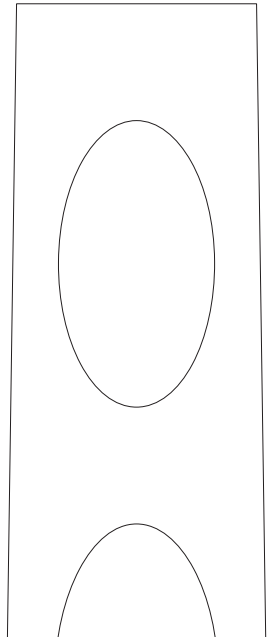
A horizontal row of five triangles. Each triangle is composed of two smaller triangles meeting at a vertex. The top triangle of each pair points upwards, and the bottom triangle points downwards. They are arranged in a regular, repeating pattern.

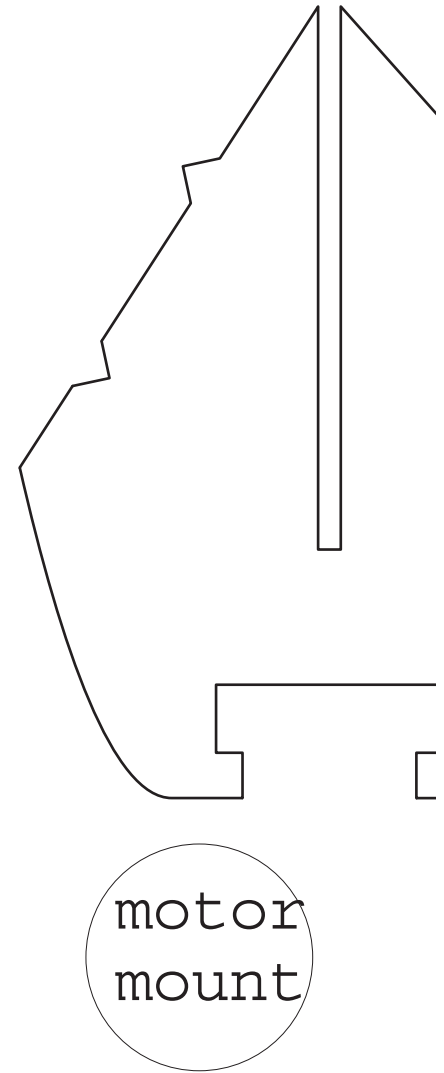
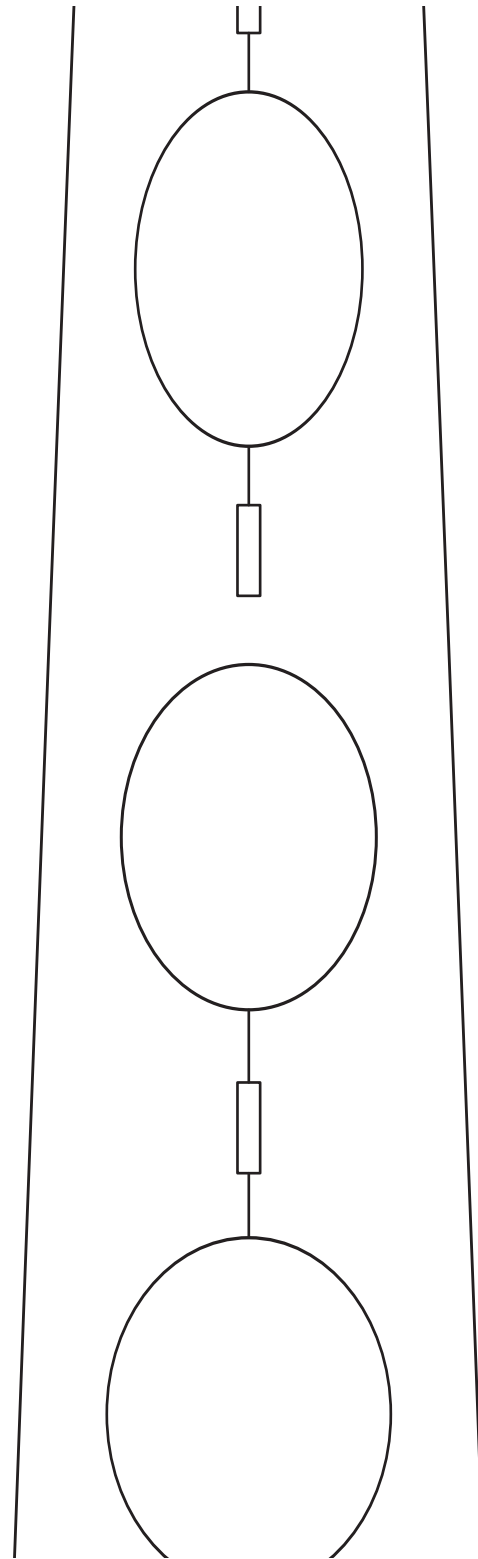
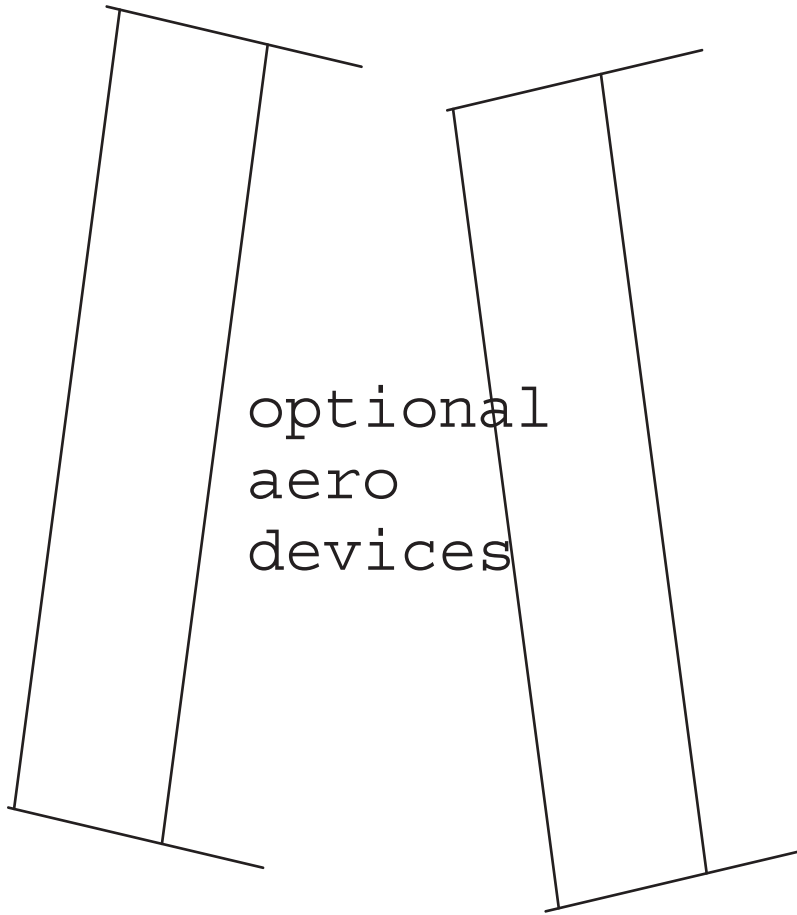

(2, 2)

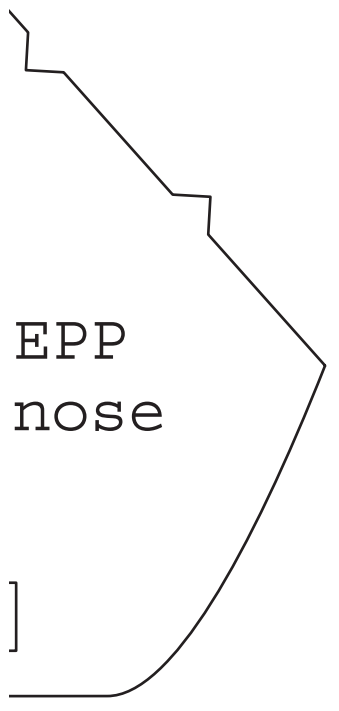

EPP
nose

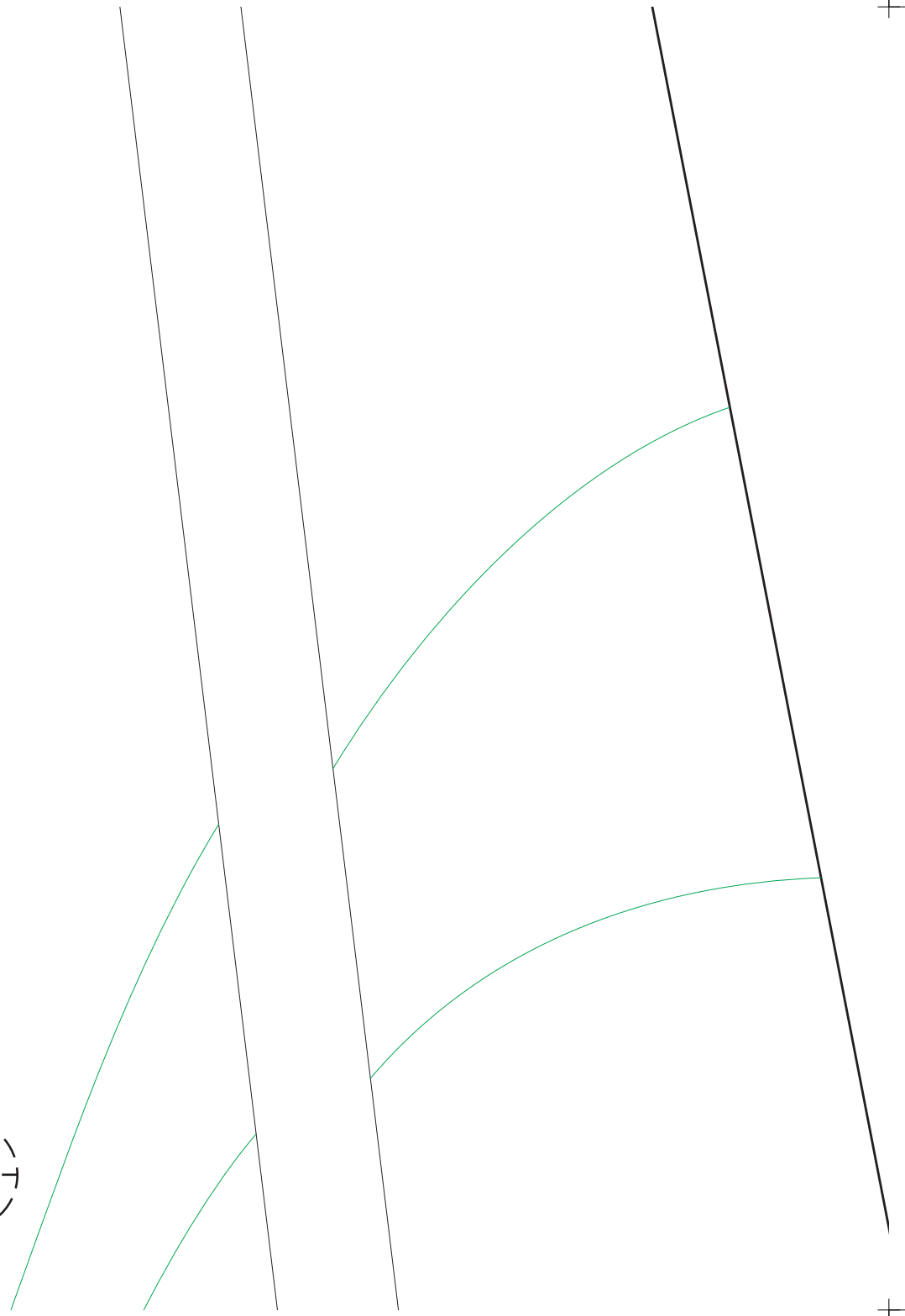
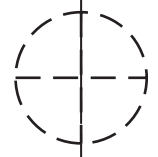
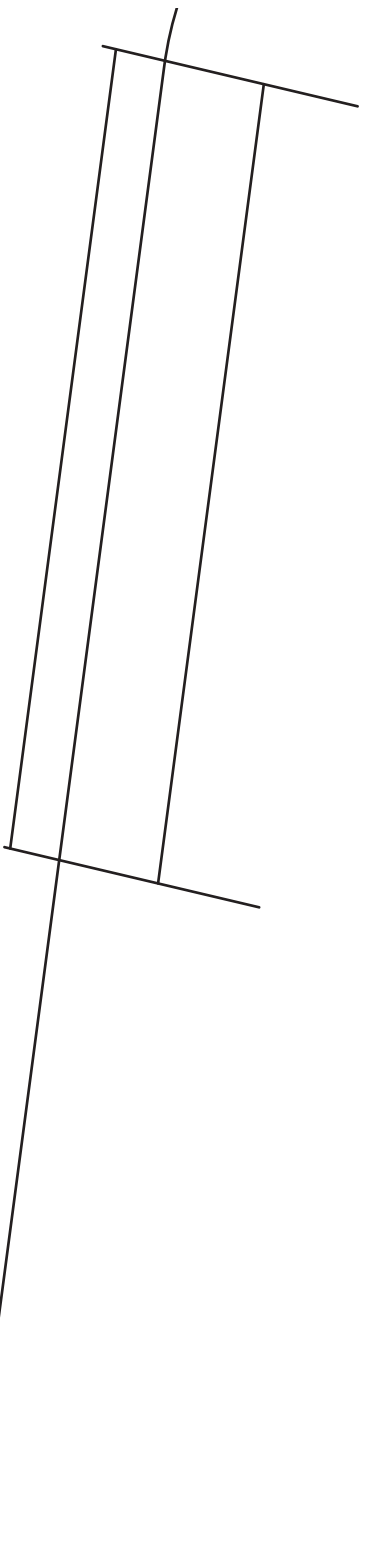

(3.2)

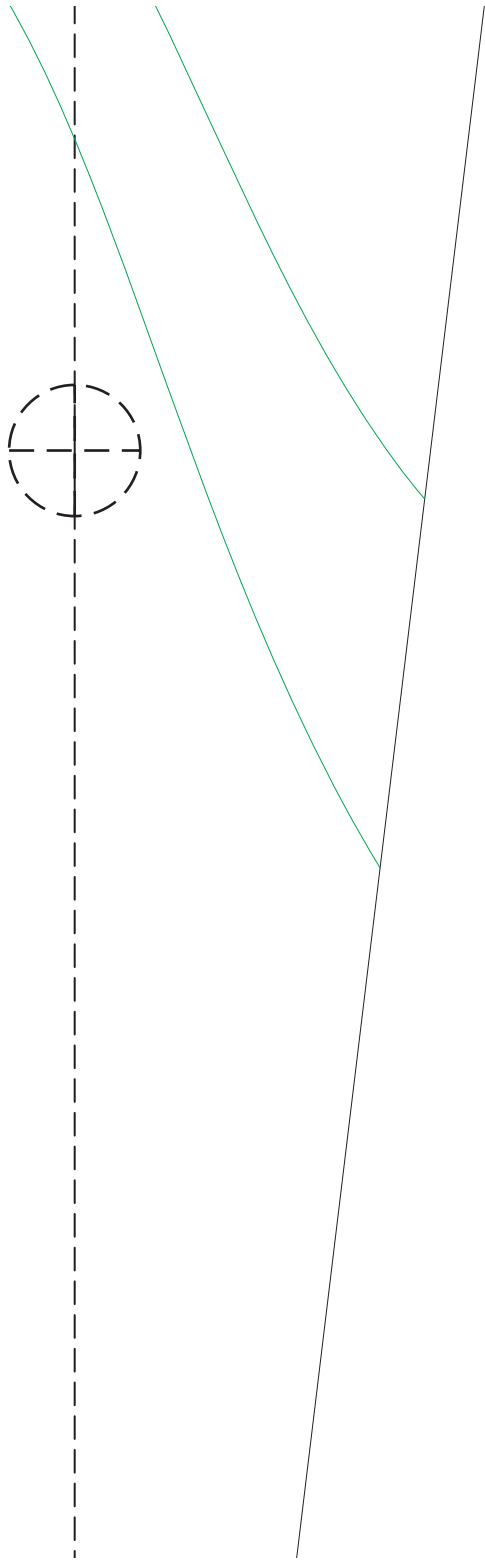
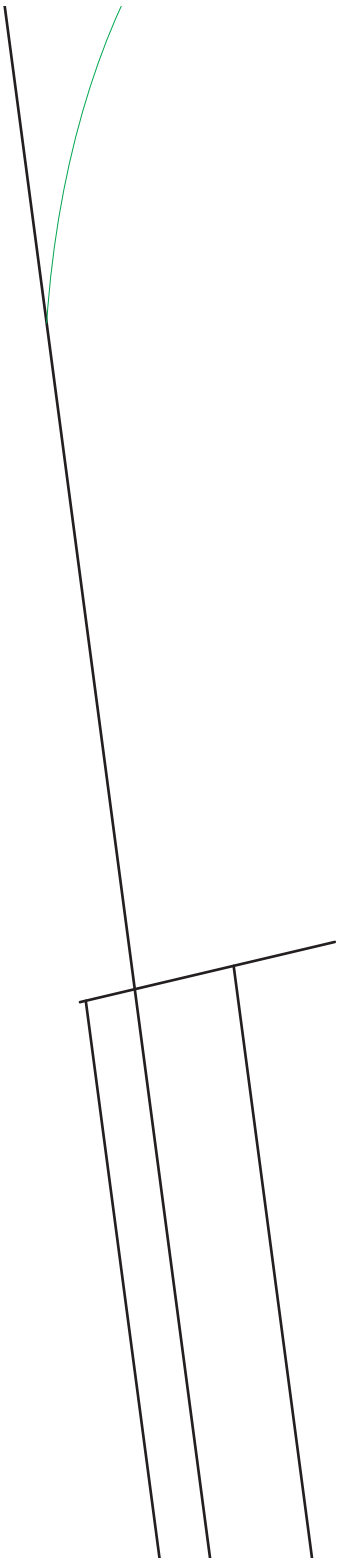

(4, 2)

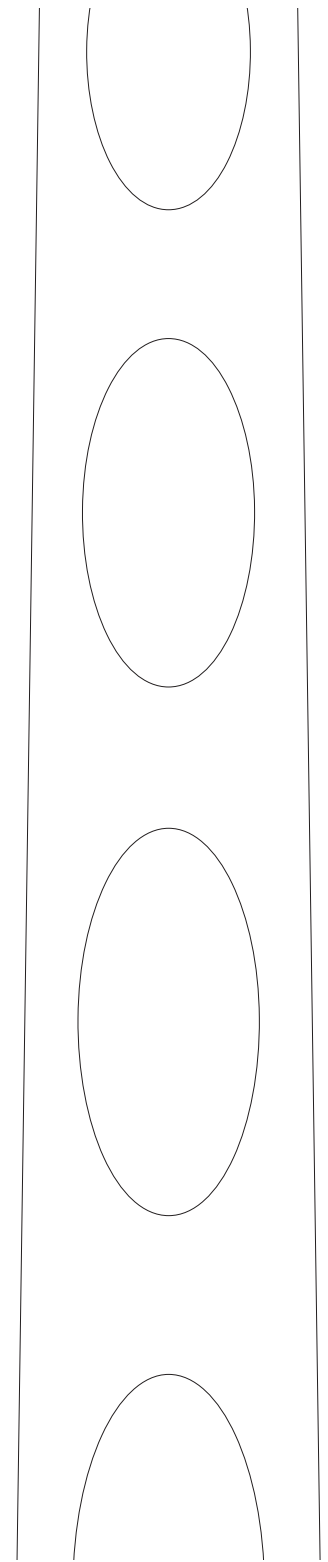
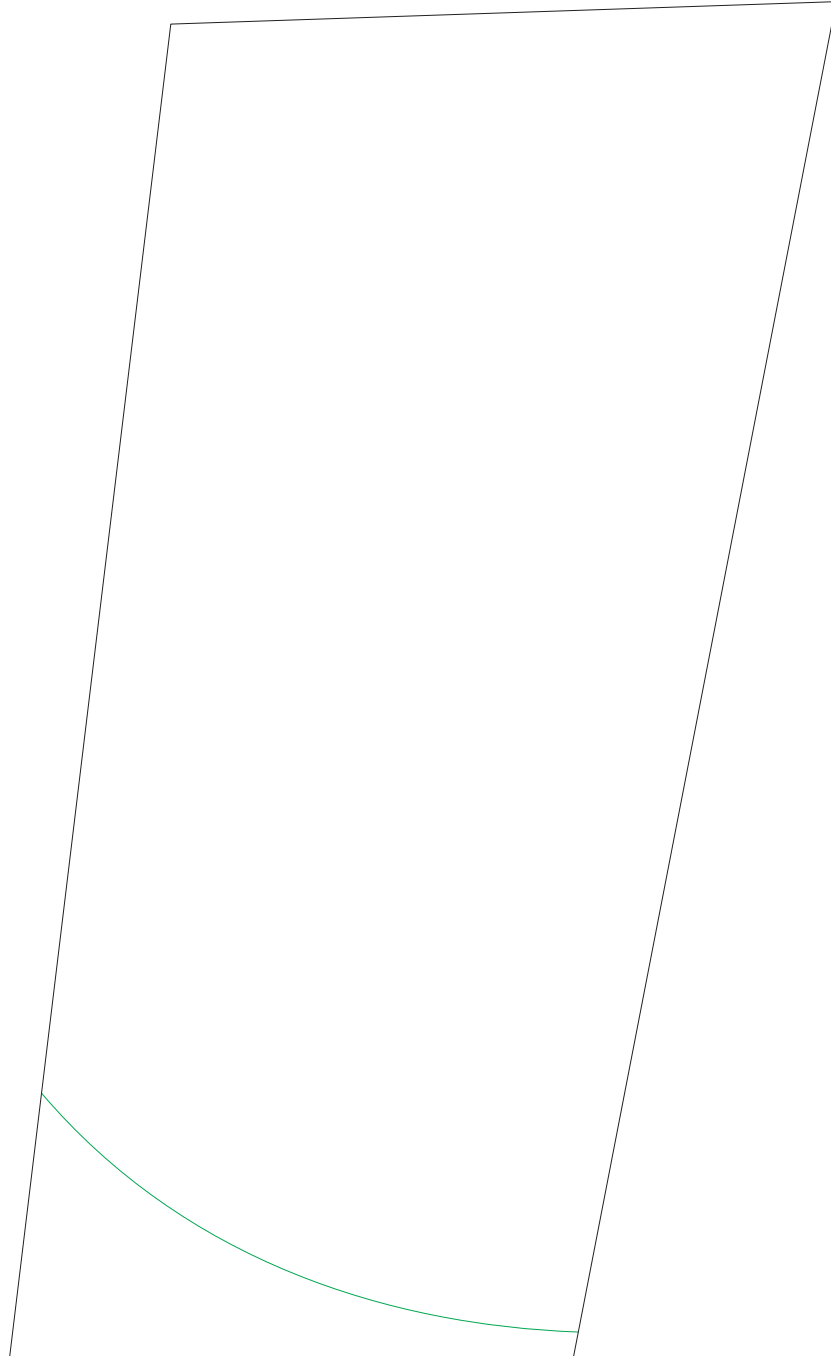

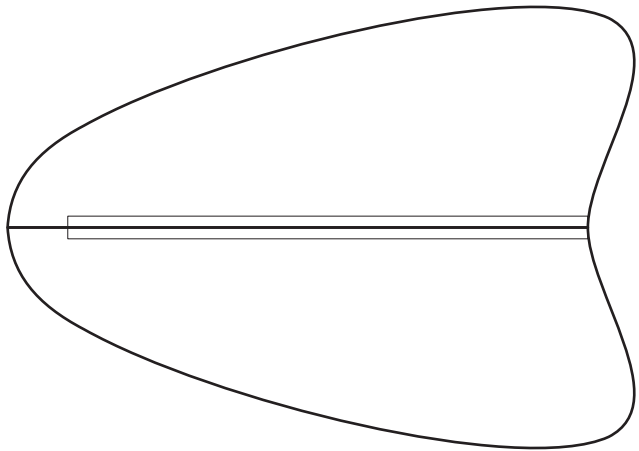

optional
SFG s

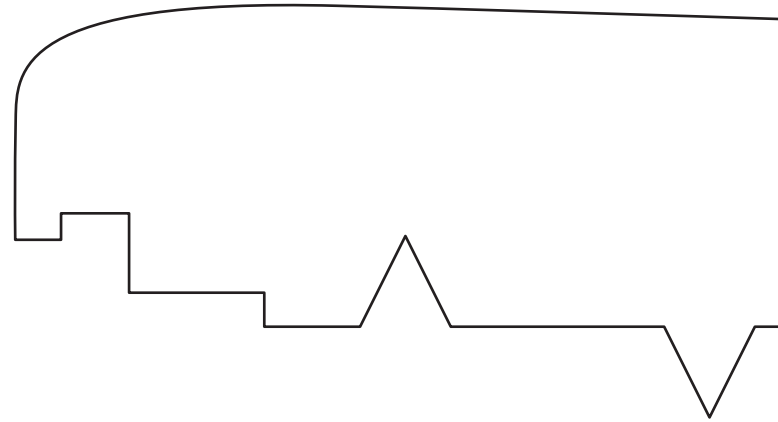
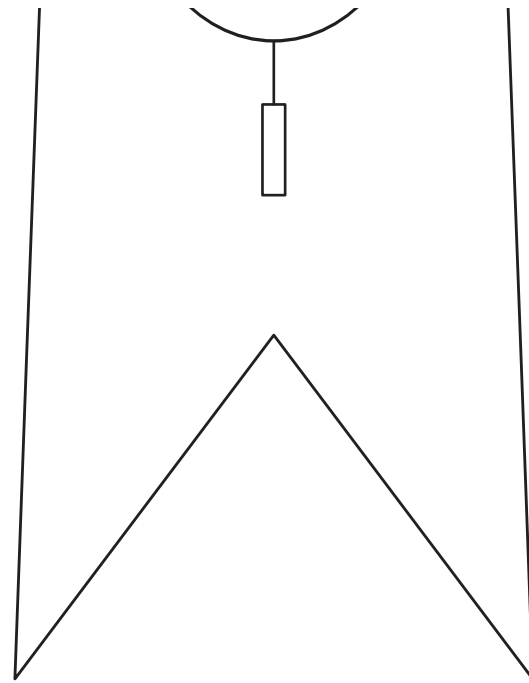
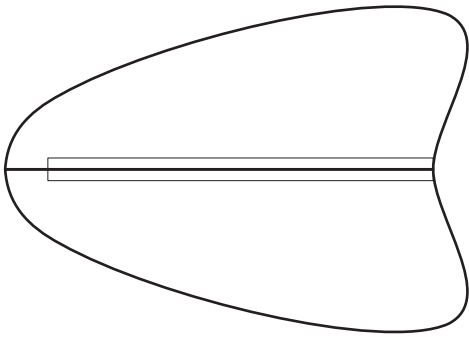

(2, 3)

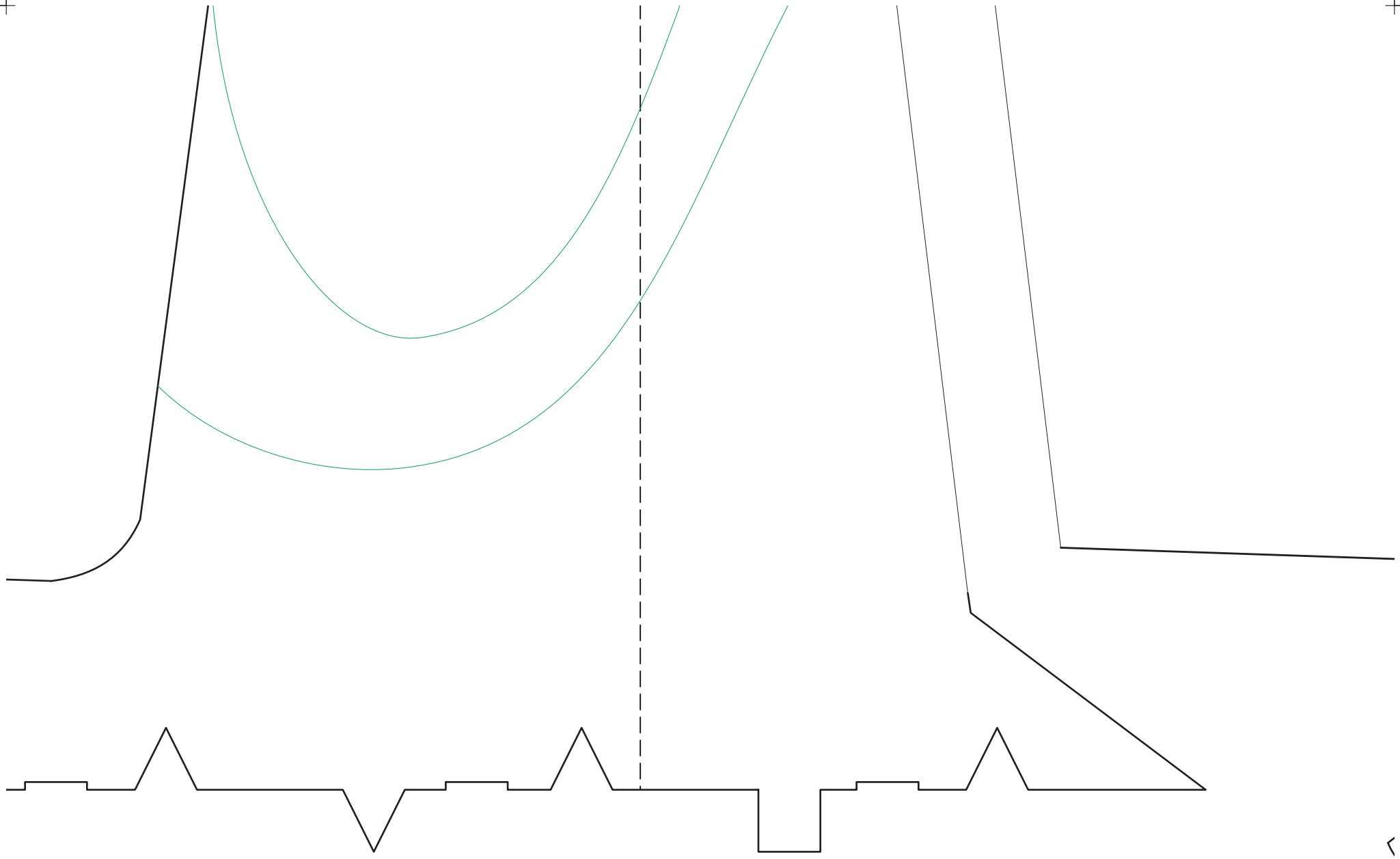

<

(3, 3)

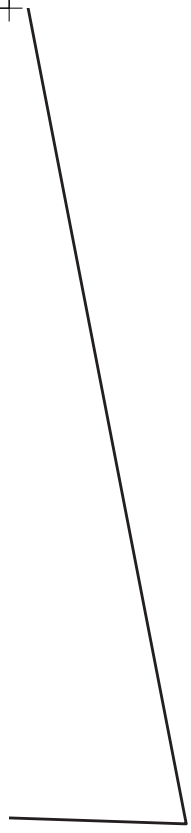
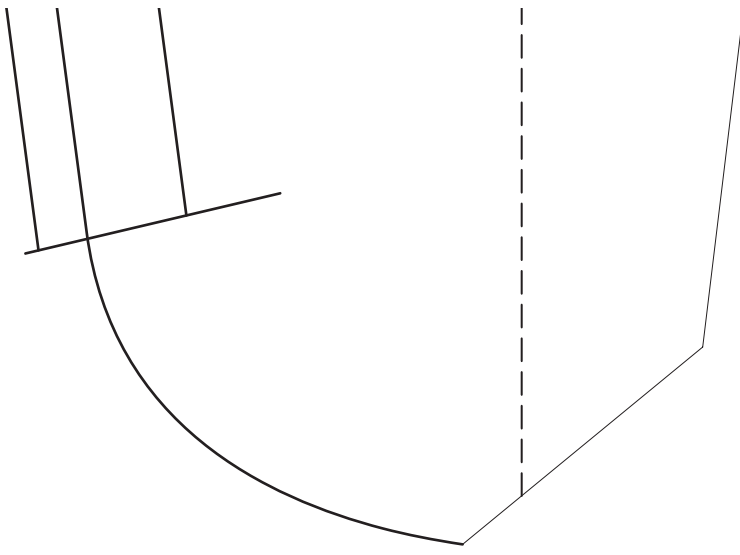

Paint template for canopy

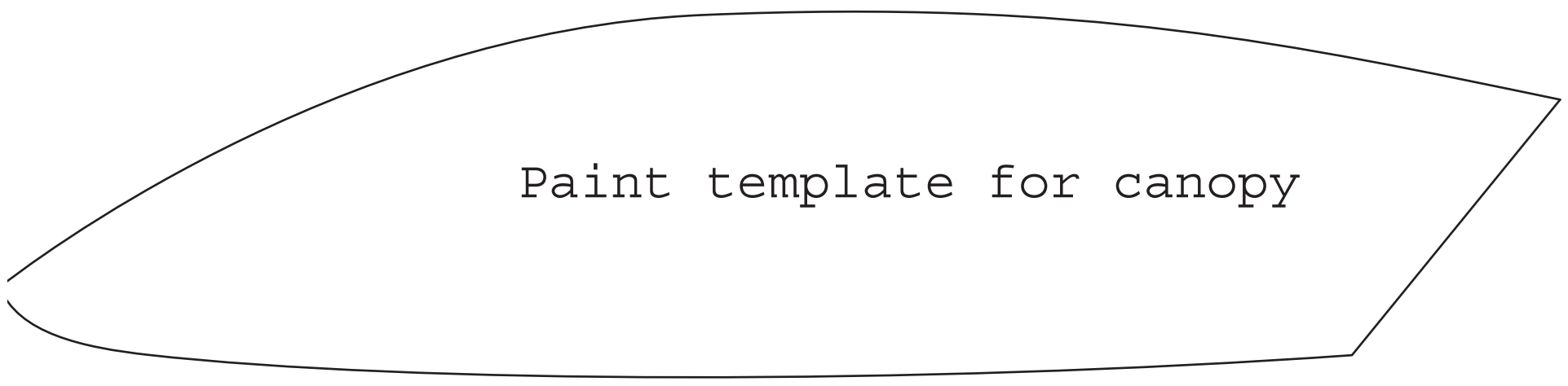

(4, 3)

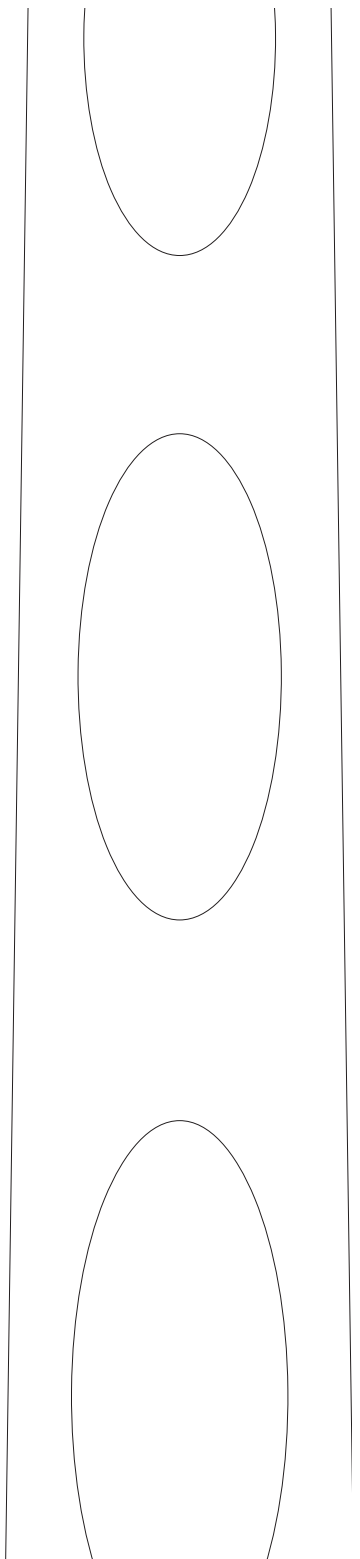
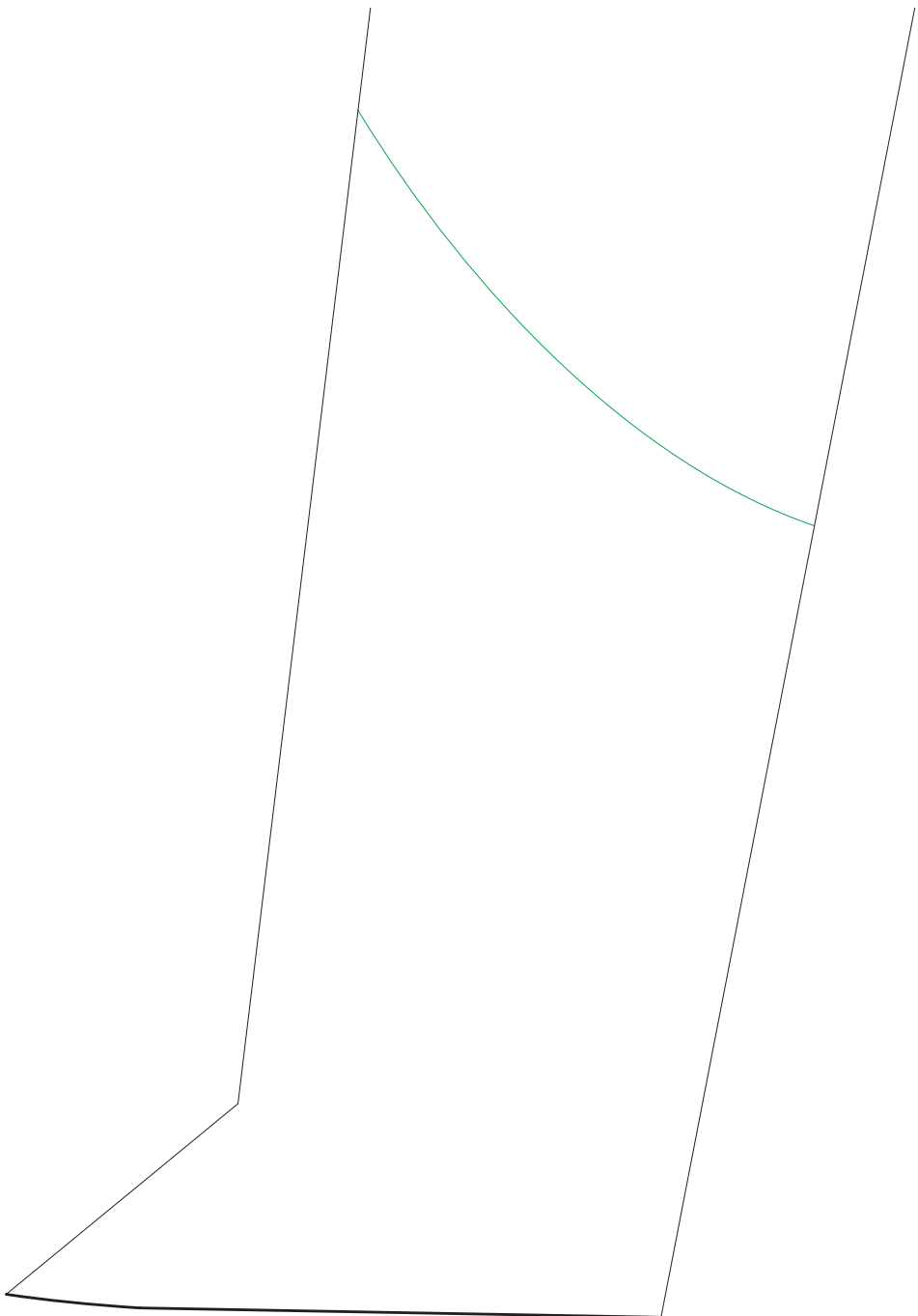

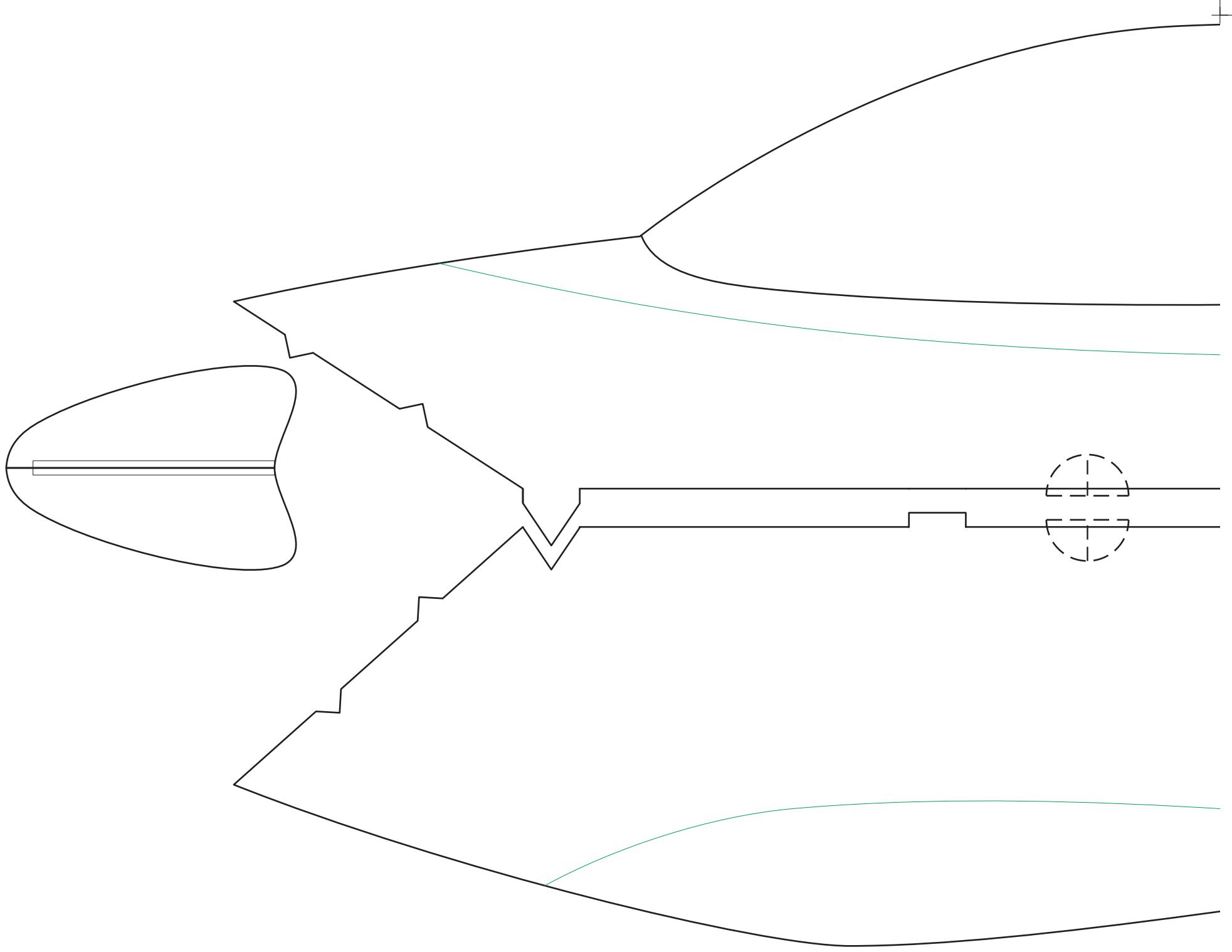

(2, 4)

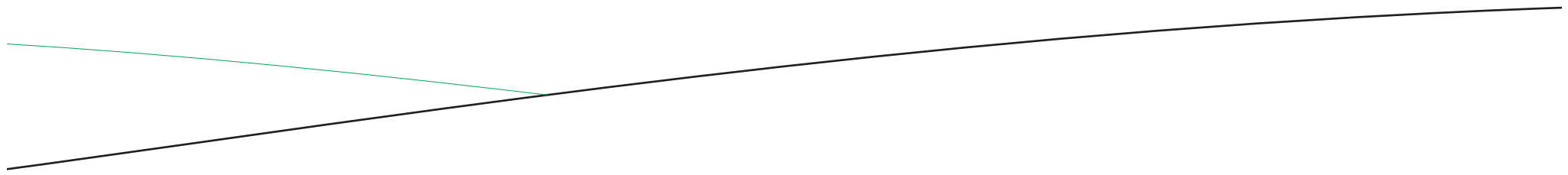
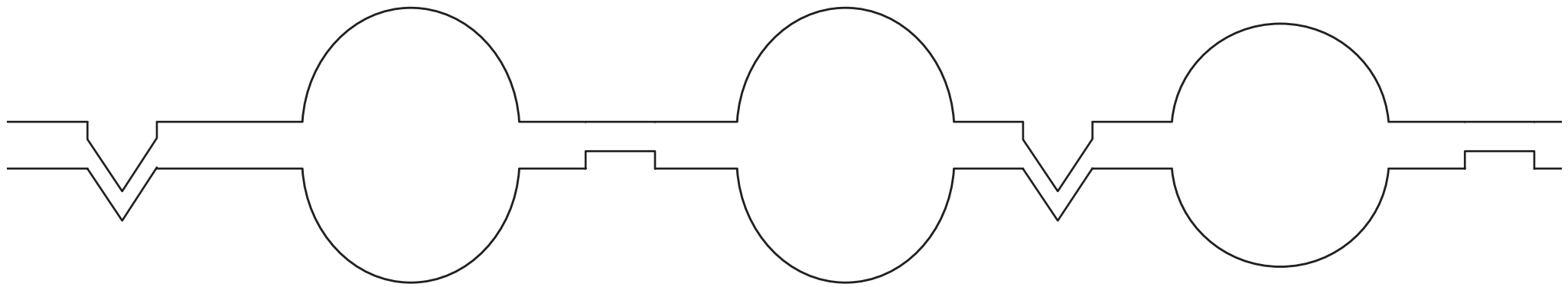
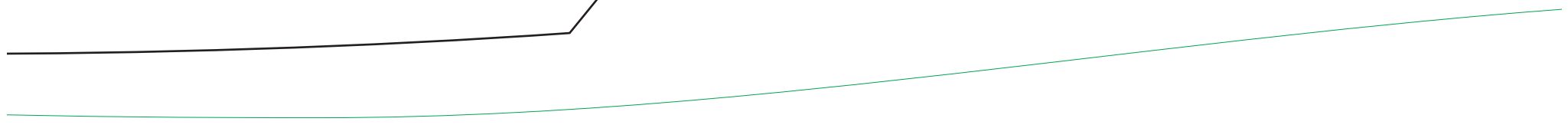
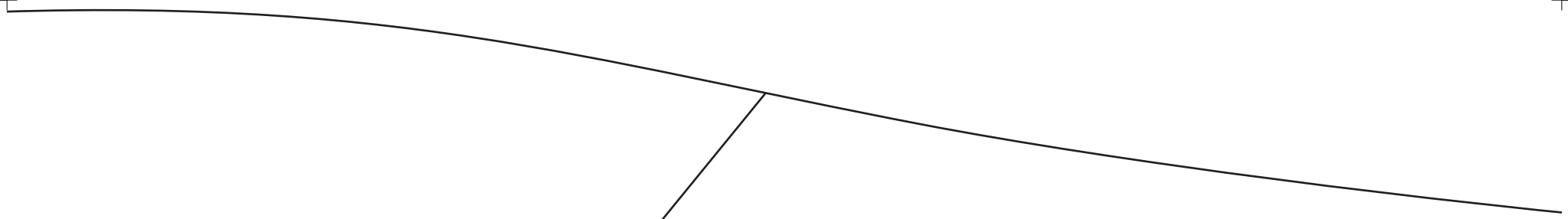

T

T

(3, 4)

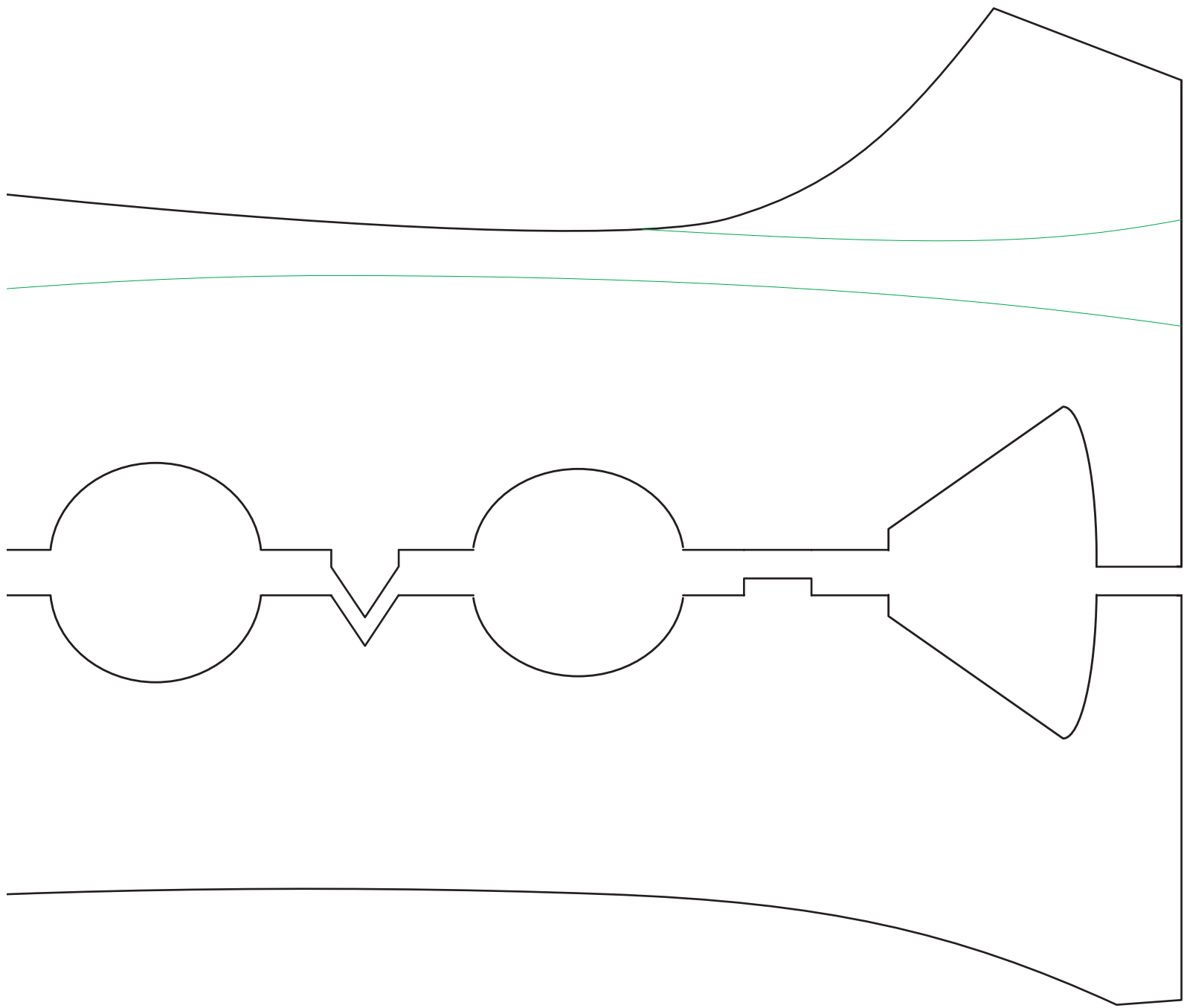

(4, 4)

