

$+1\hat{A}^\circ$

HS 55

HS 55

comp. mm2

sgancio t





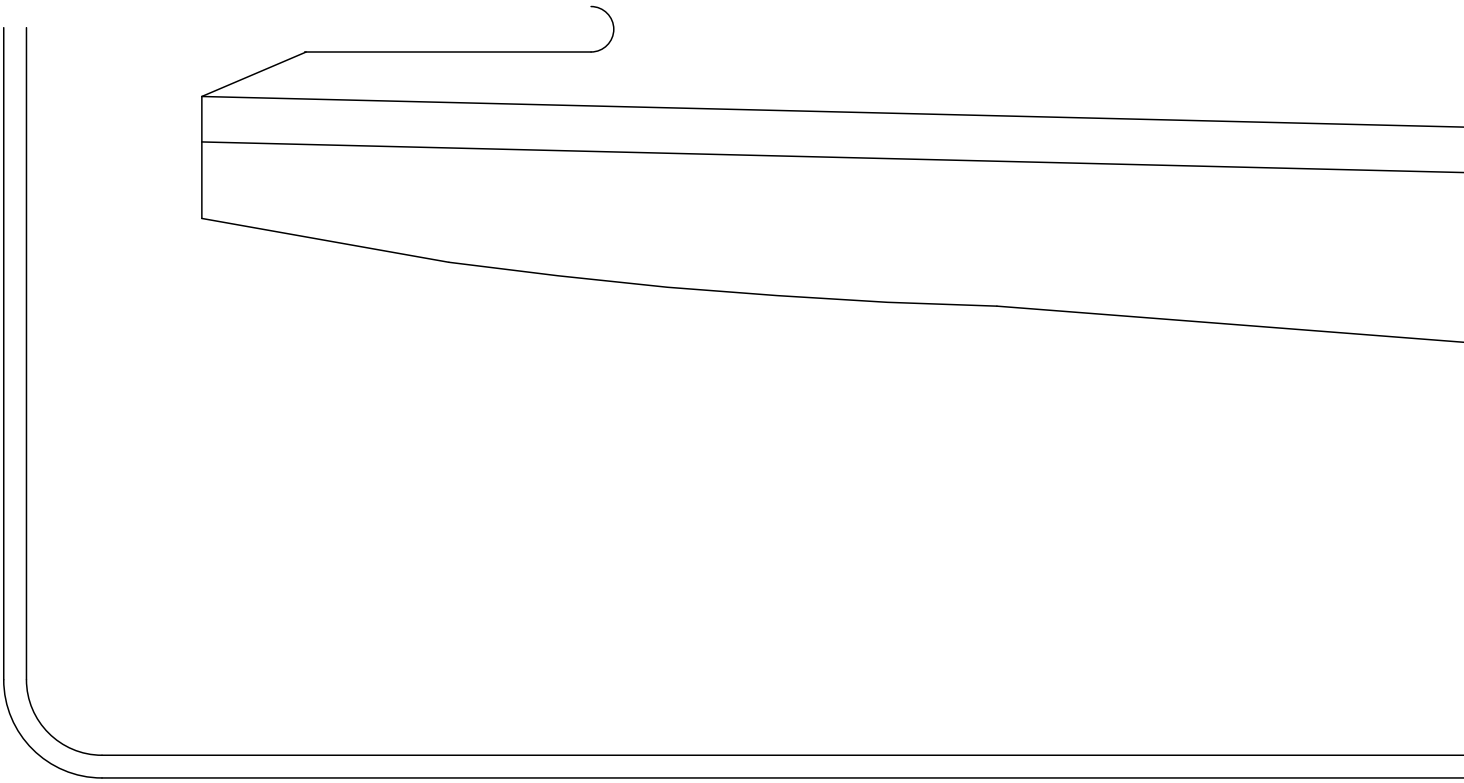

P1 depron mm6

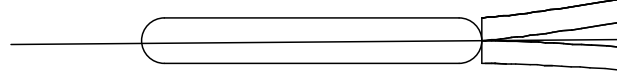

trainso aereo





linea riferimento del P1

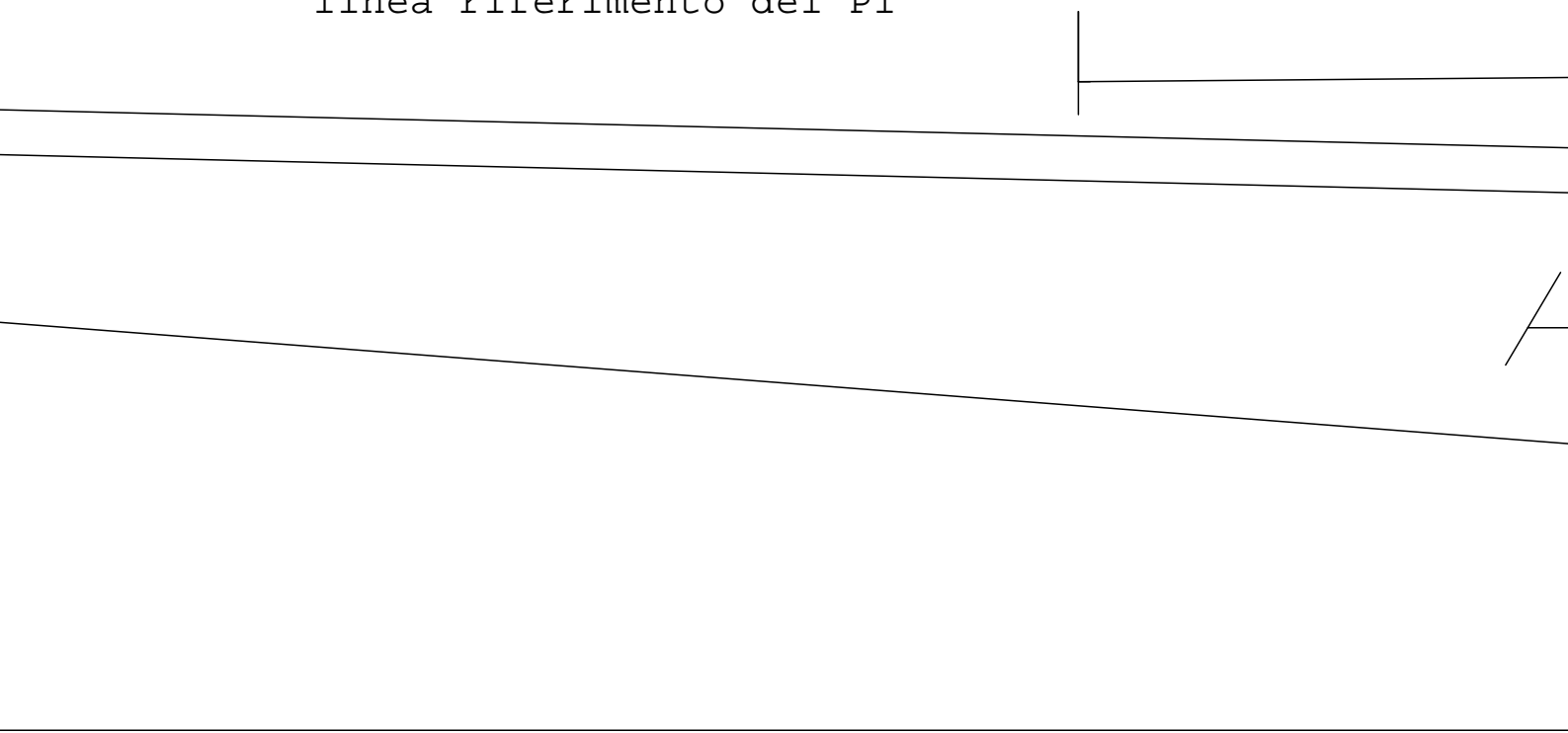

tamponare con depron mm3

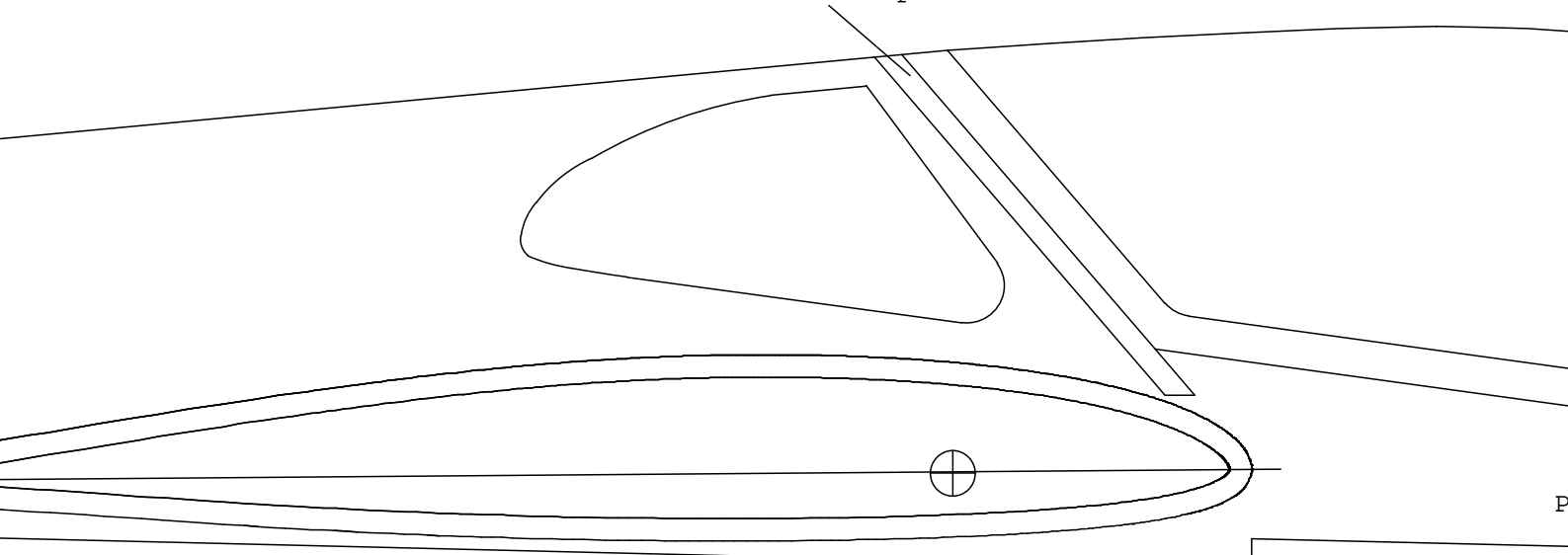

P2 depron mm3

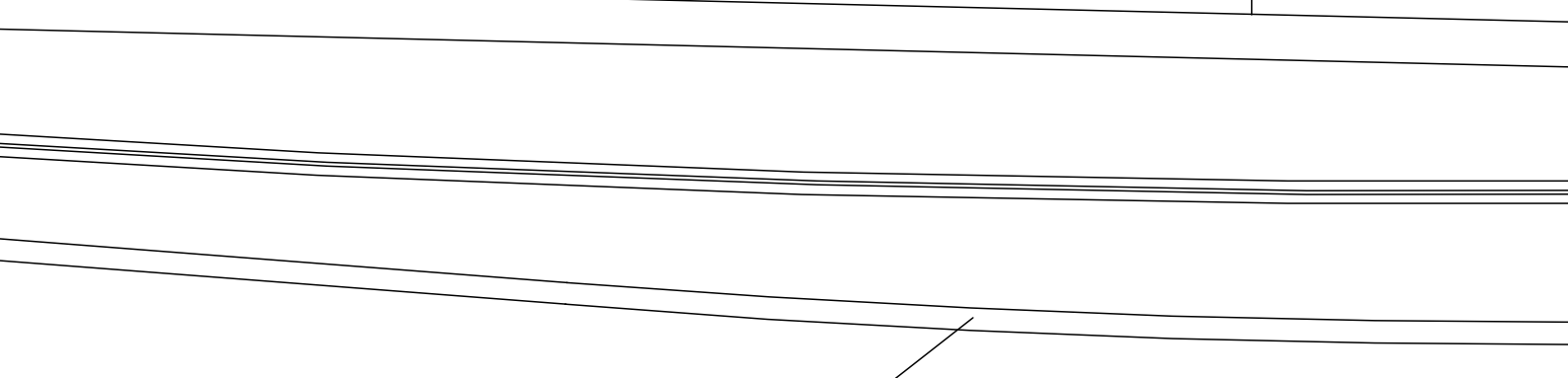







verso della vena

B

tamponare con dep.

3 comp. mm3

rivestire di fibra di vetro resinata

B

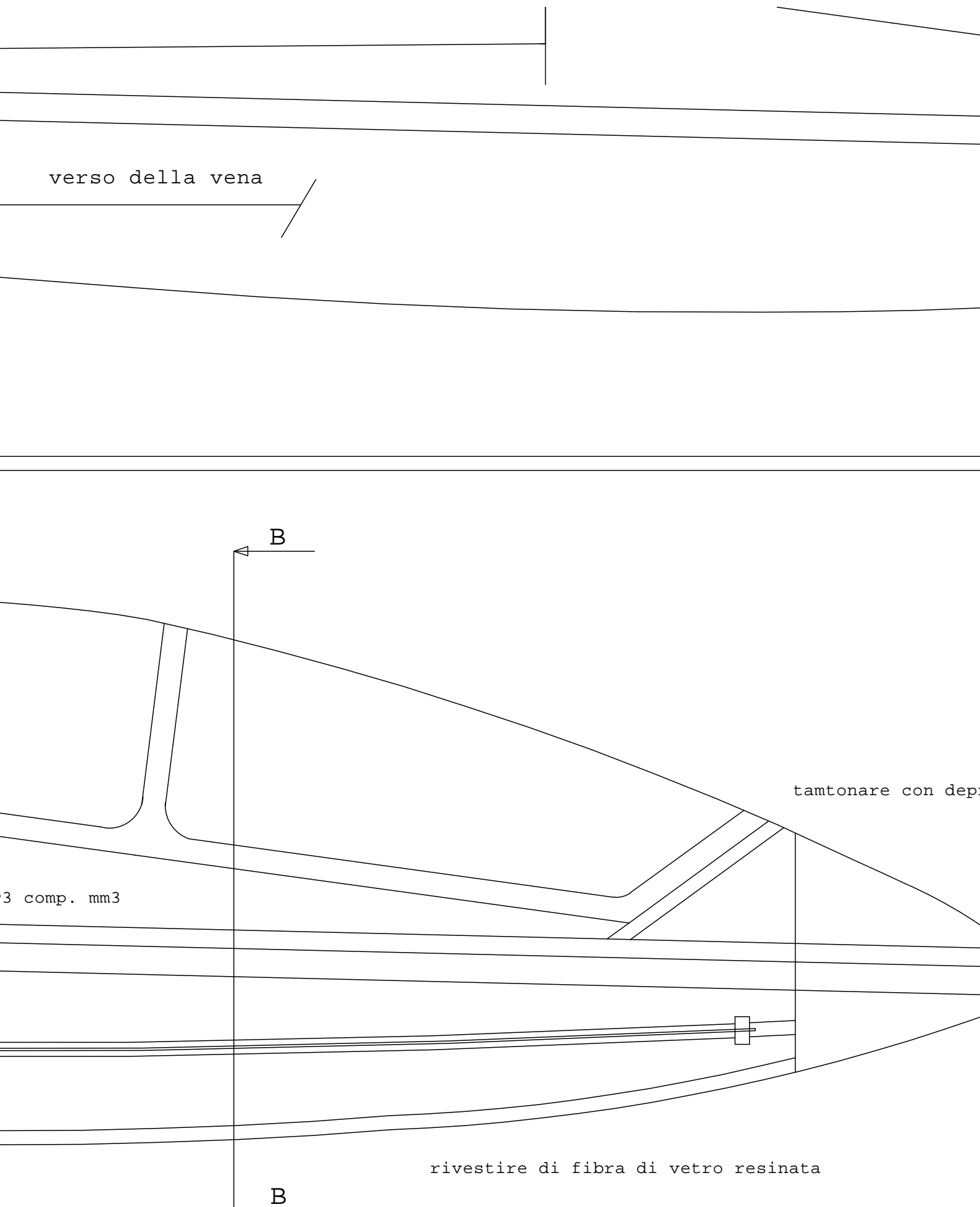





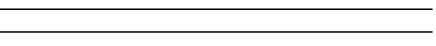
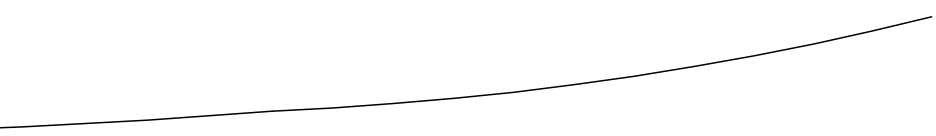
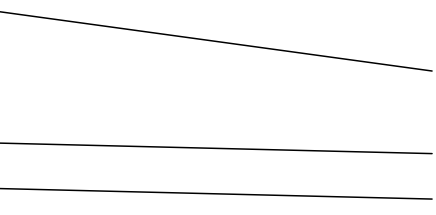

ron mm3

blocco balsa

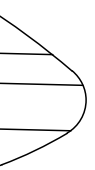

blocco balsa































