



## On the Minimum Induced Drag of Wings

Albion H. Bowers  
NASA Armstrong Chief Scientist

NASA Neil A. Armstrong Flight Research Center

NASA Neil A. Armstrong Flight Research Center



## Imagination vs Knowledge

- Requirements and Assumptions
- Concepts and Solutions

## Lift

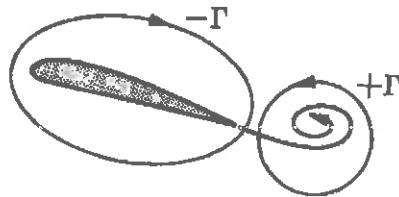

Where does lift come from?



## Personal Air Vehicles

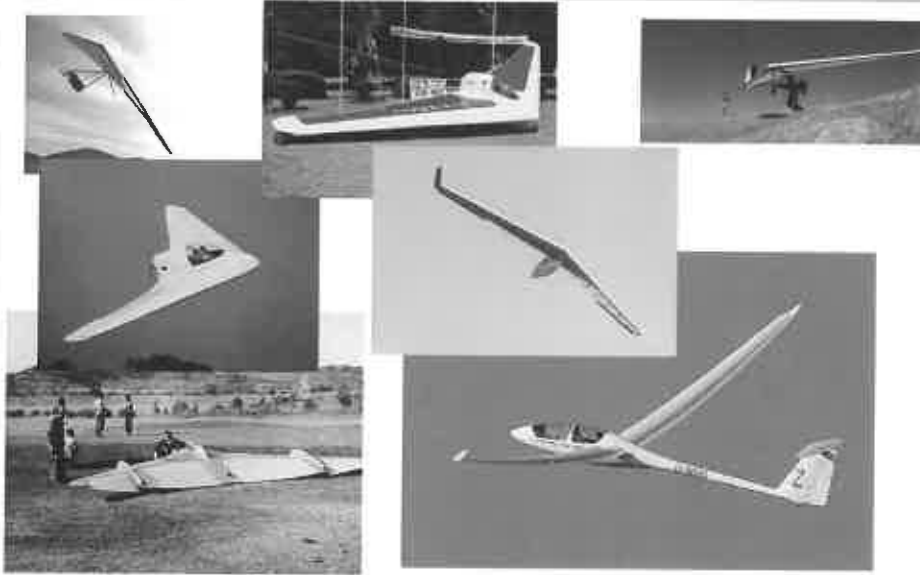

## Birds



## The Four Ways Birds Differ from Aircraft



- Birds turn and maneuver without a vertical tail
- Birds have slender tips that carry little load
- Birds gracefully fly formation with overlapped wingtips
- Birds have narrow wingtips without tip stall

## Wilbur & Orville Wright

- Flying experiments 1899 to 1905

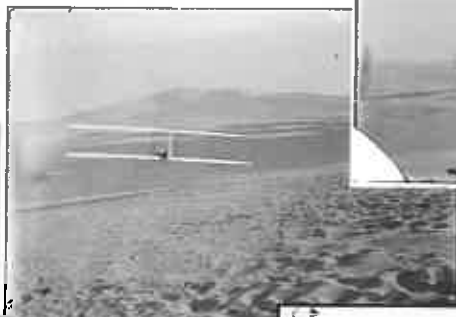
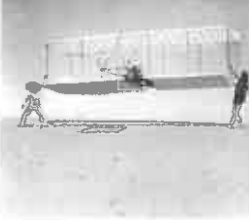
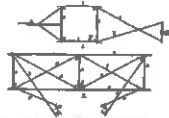

Patent #821,393

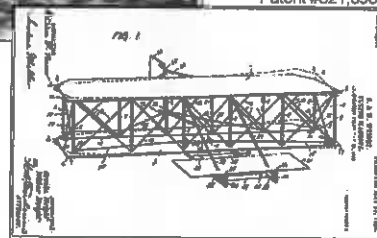

## Prandtl Lifting Line Theory

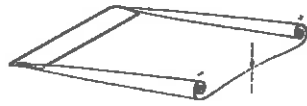

- Prandtl's "vortex ribbons"

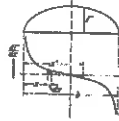

- Elliptical spanload for a given span (1920)
- "the downwash produced by the longitudinal vortices must be uniform at all points on the aerofoils in order that there may be a minimum of drag for a given total lift."  $y = c$



Ludwig Prandtl

This is the accepted theory and the standard for the minimum drag of wings. But what is a wing? Is it only aerodynamic? What about the structure?

## Minimum Induced Drag & Bending Moment

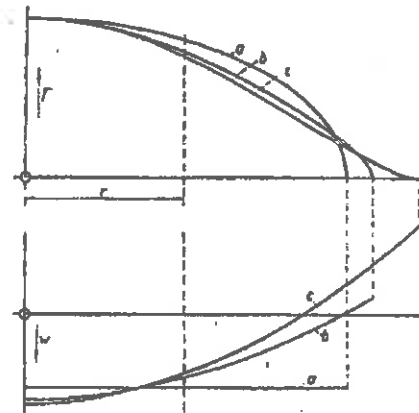

- Prandtl (1932)  
 Constrain minimum induced drag  
 Constrain integrated wing bending moment  
 22% increase in span with 11% decrease in induced drag

### Horten Applies the Bbell Spanload

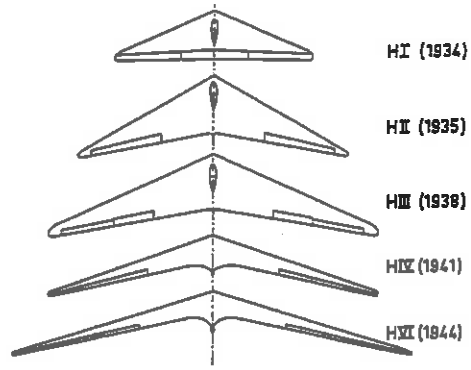
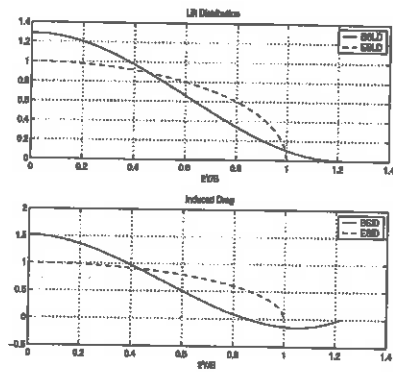

Horten Sailplanes

- Horten Spanload (1934-1954) use twist to achieve spanload induced thrust at tips no structural implications

### Horten Sailplanes (Germany & Argentina)

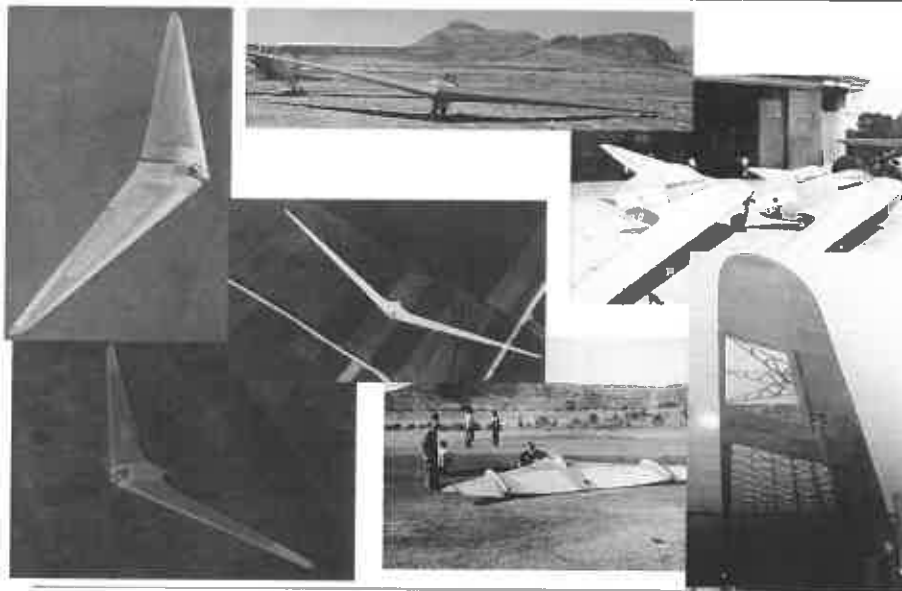

## Prandtl & Horten



## Jones Spanload

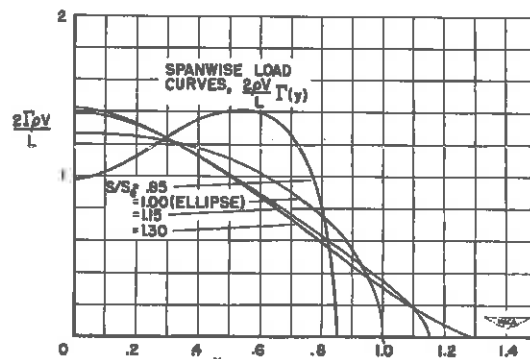

- Minimize induced drag (1950)  
Constrain wing root bending moment  
30% increase in span with 17% decrease in induced drag
- "Hence, for a minimum induced drag with a given total lift and a given bending moment the downwash must show a linear variation along the span."  $y = bx + c$

## Klein and Viswanathan

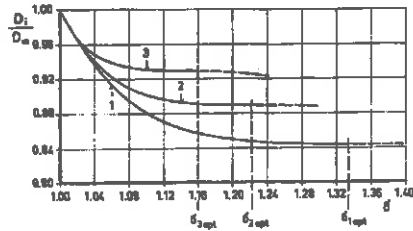

- Minimize induced drag (1975)  
 Constrain bending moment  
 Constrain shear stress  
 16% increase in span with 7% decrease in induced drag
- "Hence the required downwash-distribution is parabolic."  $y = ax^2 + bx + c$

## Winglets

- Richard Whitcomb's Winglets
  - induced thrust on wingtips
  - induced drag decrease is about half of the span "extension"
  - reduced wing root bending stress

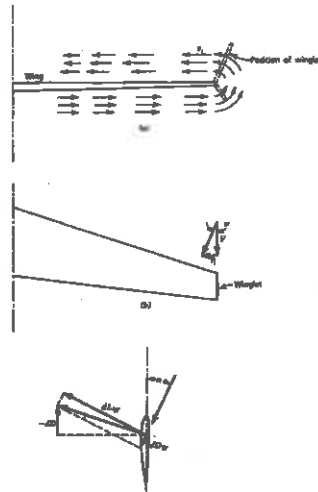
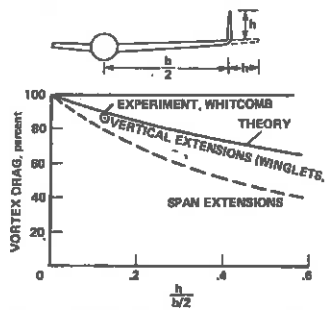



## Whitcomb's Winglets



NASA Dryden Flight Research Center Photo Collection  
<http://www.dfrc.nasa.gov/gallery/photo/index.html>  
 NASA Photo: 027811114 Date: 1978  
 X-45 in flight - winglet study



NASA Dryden Flight Research Center Photo Collection  
<http://www.dfrc.nasa.gov/gallery/photo/index.html>  
 NASA Photo: 027811481 Date: 1978  
 X-45 in flight - closeup of winglet with attached tabs

## Prandtl(1920) vs Prandtl(1932)

**Prandtl  
1920**  
**Elliptical  
Spanload**

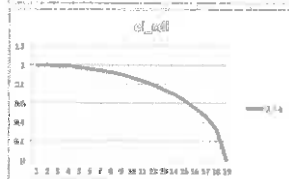

**Prandtl  
1932**  
**Bell  
Spanload**

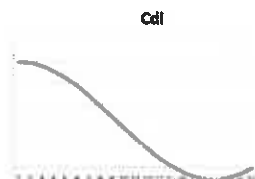
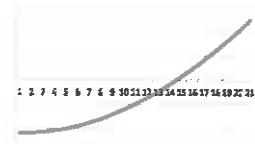
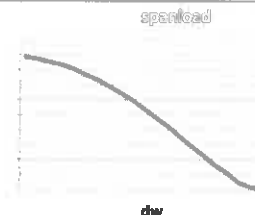

## Spanload, Downwash, Induced Drag

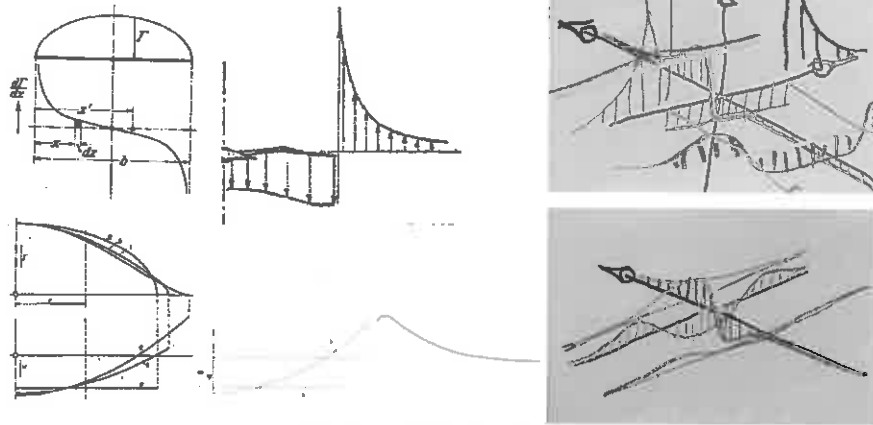

- All wings dictate 3 solutions
- Spanload
- Downwash
- Induced Drag

## Horten H Xc Example

- Horten H Xc footlaunched ultralight sailplane 1950
- 24 degree leading edge sweep angle
- Chord:  
root - 63 inches  
tip - 15.75 inches
- Span: 49.2 feet

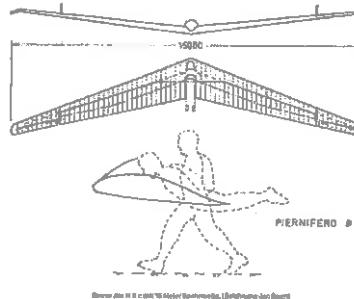

## Prandtl Wing

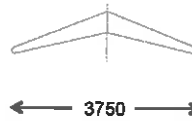
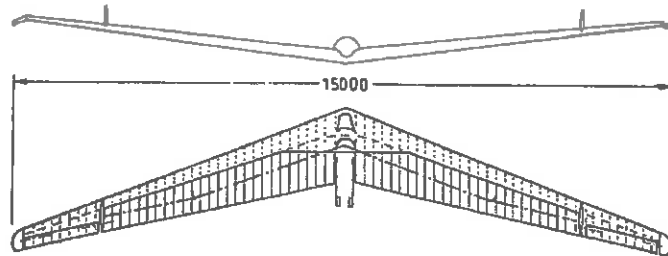

- 24 degree leading edge sweep angle
- Chord:  
root – 15.75 inches  
tip – 3.875 inches
- Span: 147.6 inches

## Calculation Method

- Taper
- Twist
- Control Surface Deflections
- Central Difference Angle

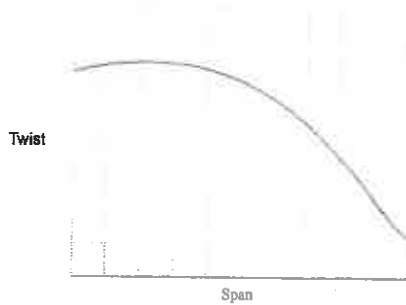

R0	8.3274
R1	8.5524
R2	8.7259
R3	8.8441
R4	8.9030
R5	8.8984
R6	8.8257
R7	8.6801
R8	8.4565
R9	8.1492
R10	7.7522
R11	7.2582
R12	6.6834
R13	5.9579
R14	5.1362
R15	4.1927
R16	3.1253
R17	1.9394
R18	0.6589
R19	-0.6417
R20	-1.6726

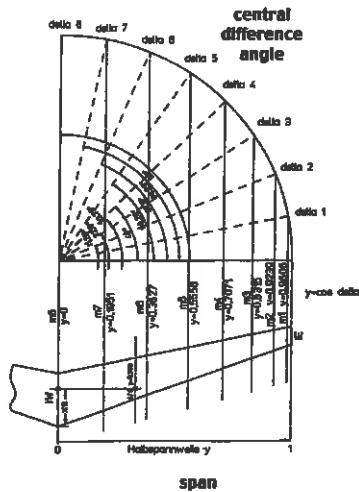

## Dr Edward Uden's Results

- Spanload and Induced Drag
- Elevon Configurations
- Induced Yawing Moments

Elevon Config	$C_{n\delta a}$	Spanload
I	-.002070	bell
II	.001556	bell
III	.002788	bell
IV	-.019060	elliptical
V	-.015730	elliptical
VI	.001942	bell
VII	.002823	bell
VIII	.004529	bell
IX	.005408	bell
X	.004132	bell
XI	.005455	bell

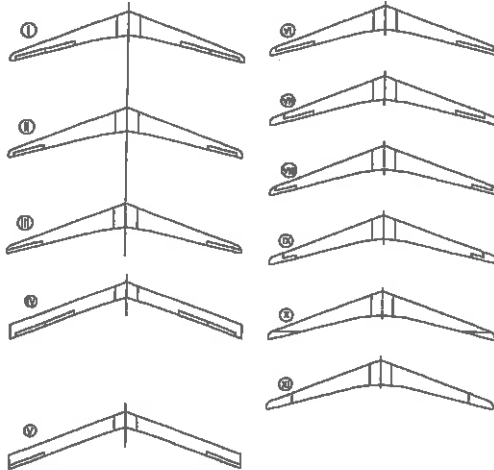

## Elliptical Half-Lemniscate

- Minimum induced drag for given control power (roll)
- Dr Richard Eppler: FS-24 Phoenix

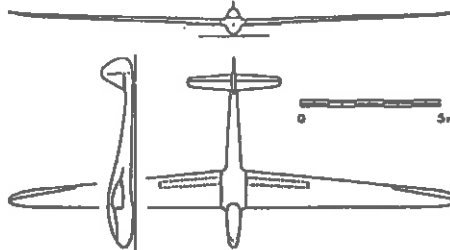
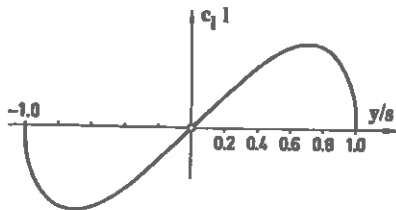

## “Mittleeffekt”

- Artifact of spanload approximations
- Effect on spanloads
  - increased load at tips
  - decreased load near centerline
- Upwash due to sweep unaccounted for

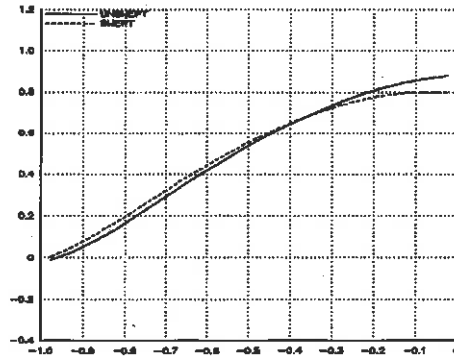

## Symmetrical Spanloads

- Elevon Trim
- CG Location

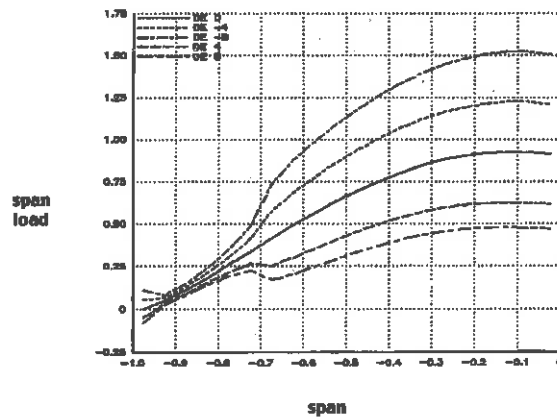

## Asymmetrical Spanloads

- $C_{l\delta a}$  (roll due to aileron)
- $C_{n\delta a}$  (yaw due to aileron)  
induced component  
profile component  
change with lift
- $C_{n\delta a}/C_{l\delta a}$
- CL (Lift Coefficient)  
Increased lift:  
increased  $C_{l\beta}$   
increased  $C_{n\beta}^*$   
Decreased lift:  
decreased  $C_{l\beta}$   
decreased  $C_{n\beta}^*$

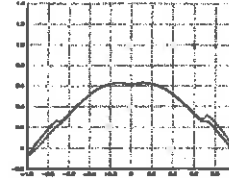
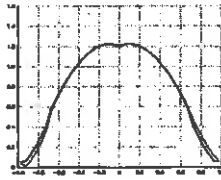
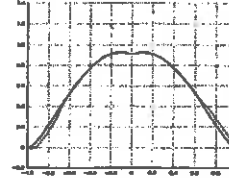
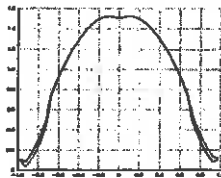

CL	C <sub>l</sub>	C <sub>n</sub>
.966	.01384	.00055
.774	.01384	.00037
.582	.01345	.00021
.390	.01384	.00003
.198	.01345	-.00015

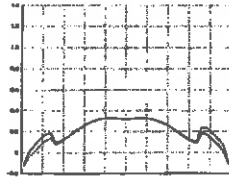

## Performance Comparison

- Max L/D: 31.9
- Min sink: 89.1 fpm
- Does not include pilot drag
  
- Predicted L/D: 30
- Predicted sink: 90 fpm

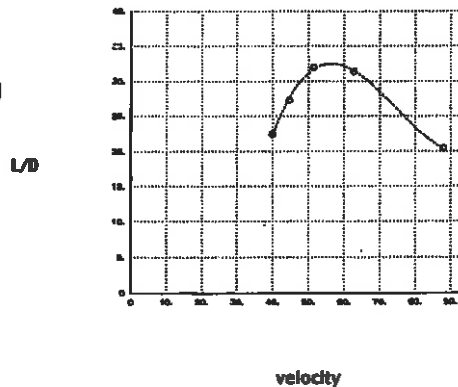

## Prandtl's Bell Spanload

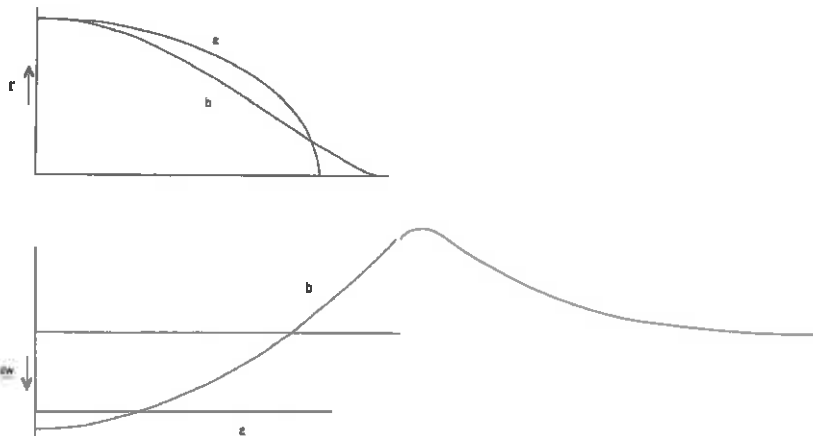

## Results of Prandtl's Spanload

$$\lim_{x: 0 \rightarrow b/2} L(x) = 0 \quad (1)$$

$$\lim_{x: 0 \rightarrow b/2} \frac{dL(x)}{dx} = 0 \quad (2)$$

$$\lim_{x: 0 \rightarrow b/2} \frac{d DW(x)}{dx} = \lim_{x: \infty \rightarrow b/2} \frac{d DW(x)}{dx} \quad (3)$$

**Mike Allen**

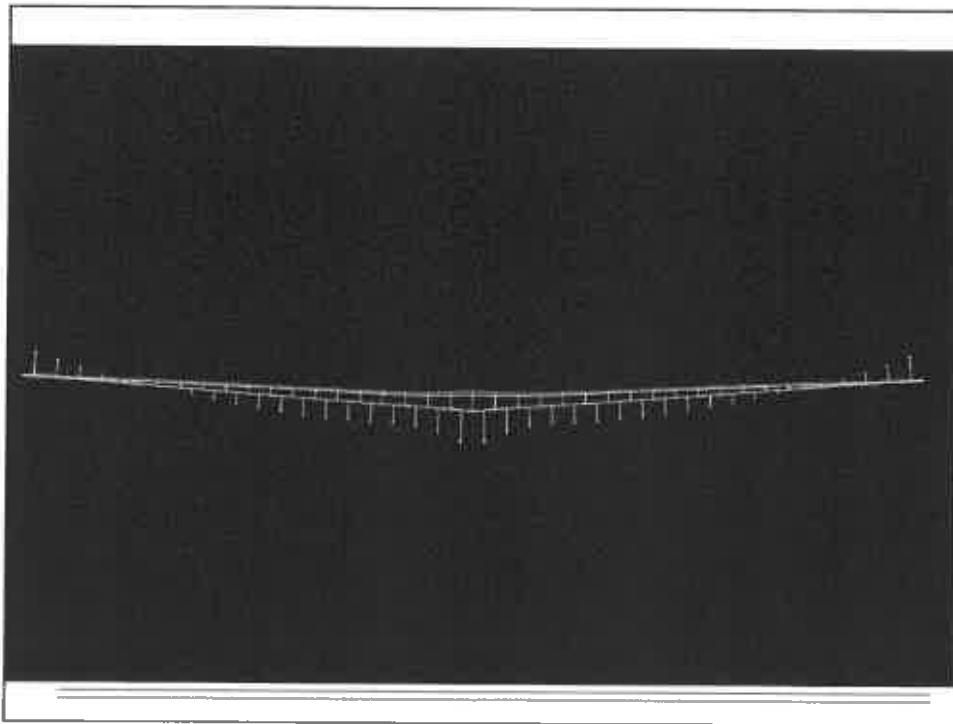



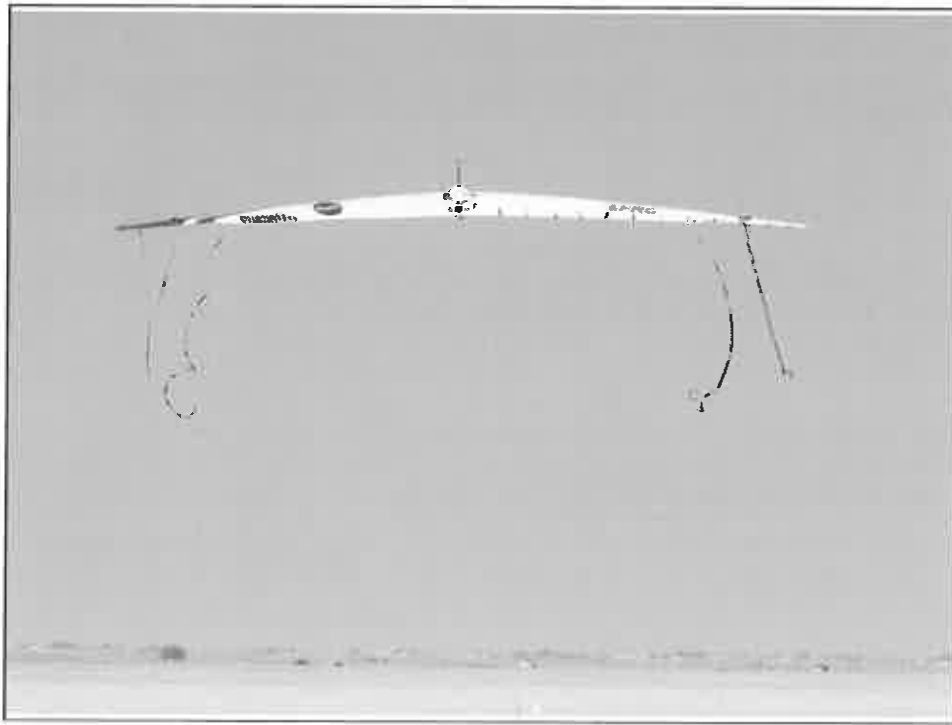
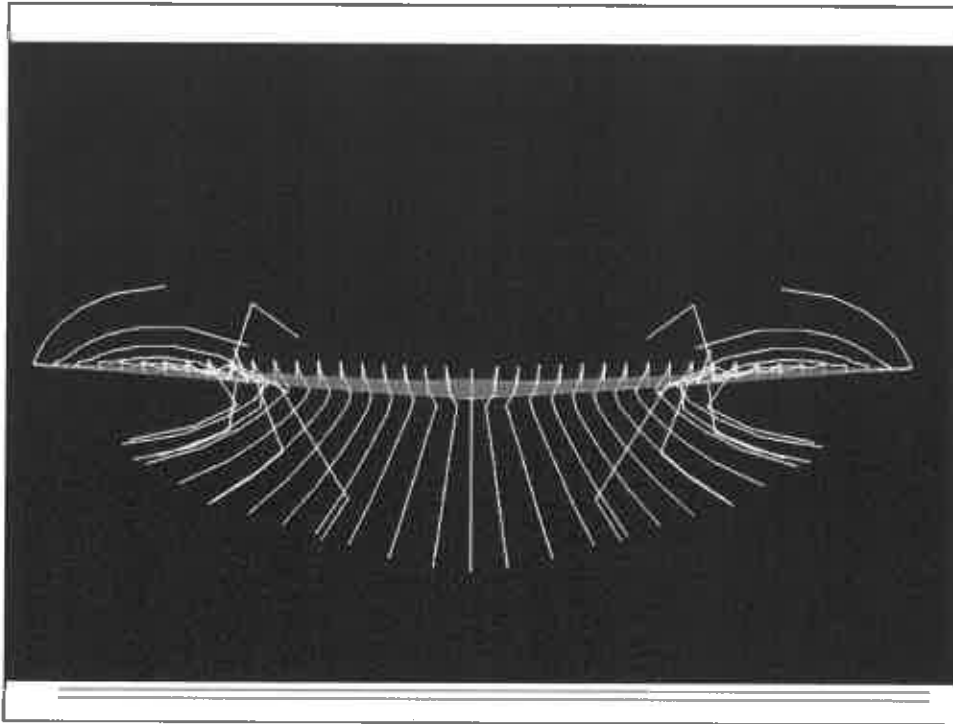

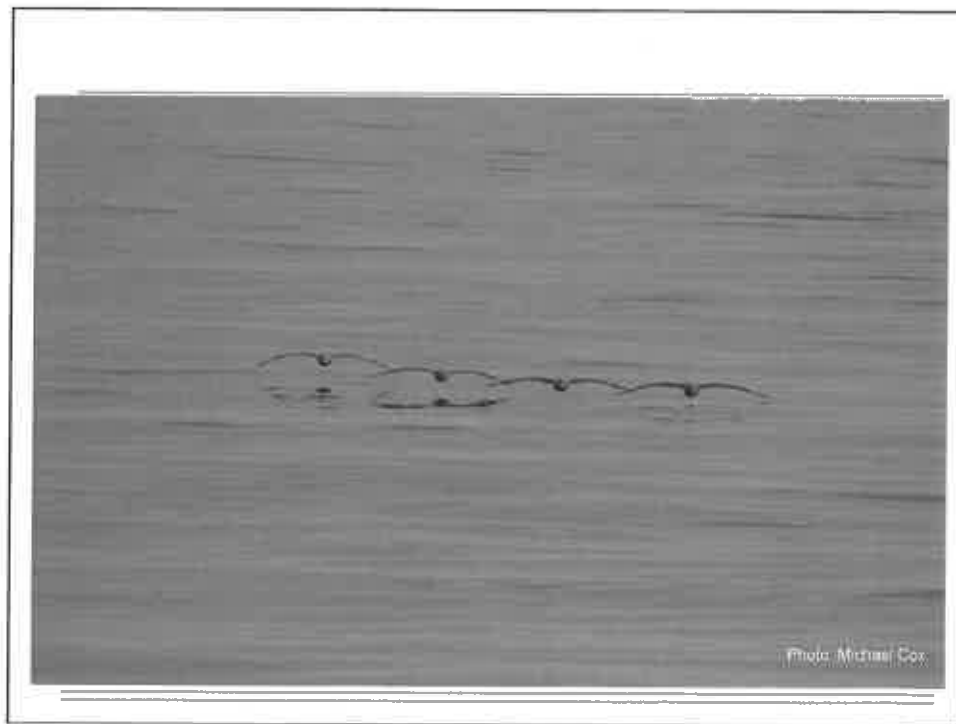
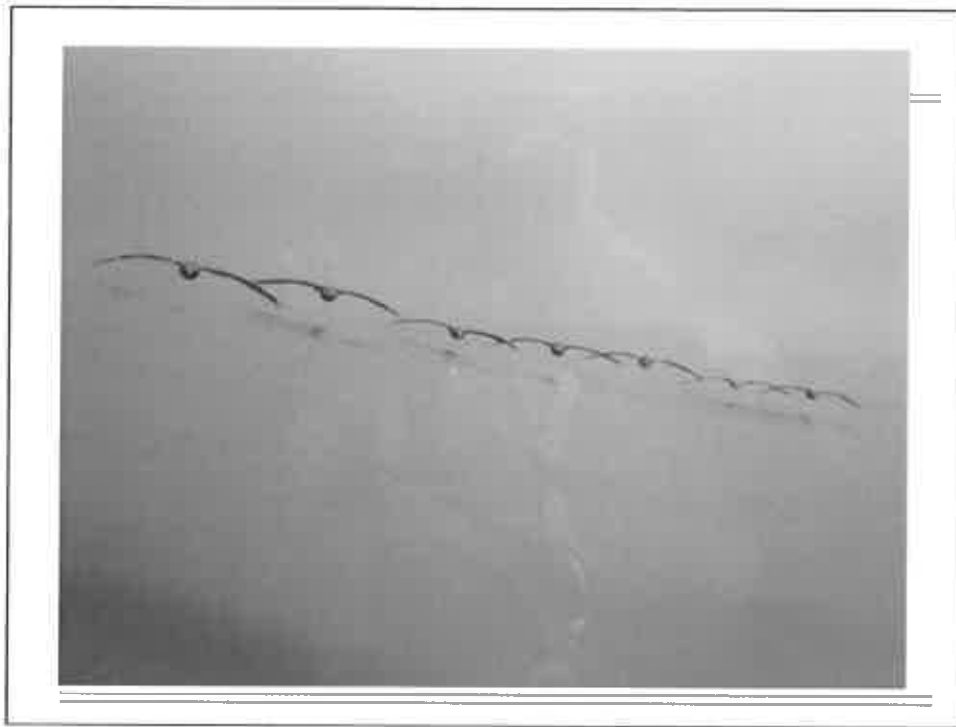

## Spanload



## Spedding's Gliding Falcon

- Spedding photograph's a gliding falcon's wake with He bubbles
- Vortex cores are 0.76 b apart
- Elliptical spanload is assumed, so the vortex cores are assumed to come from the wingtips

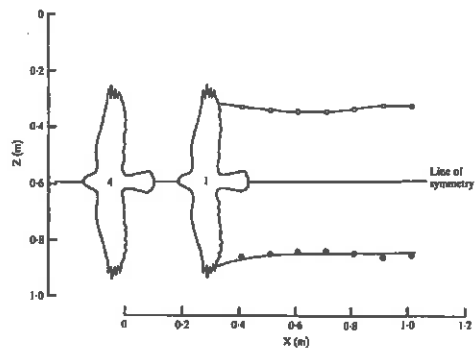

### Henningsson 2014 (PLOS One)

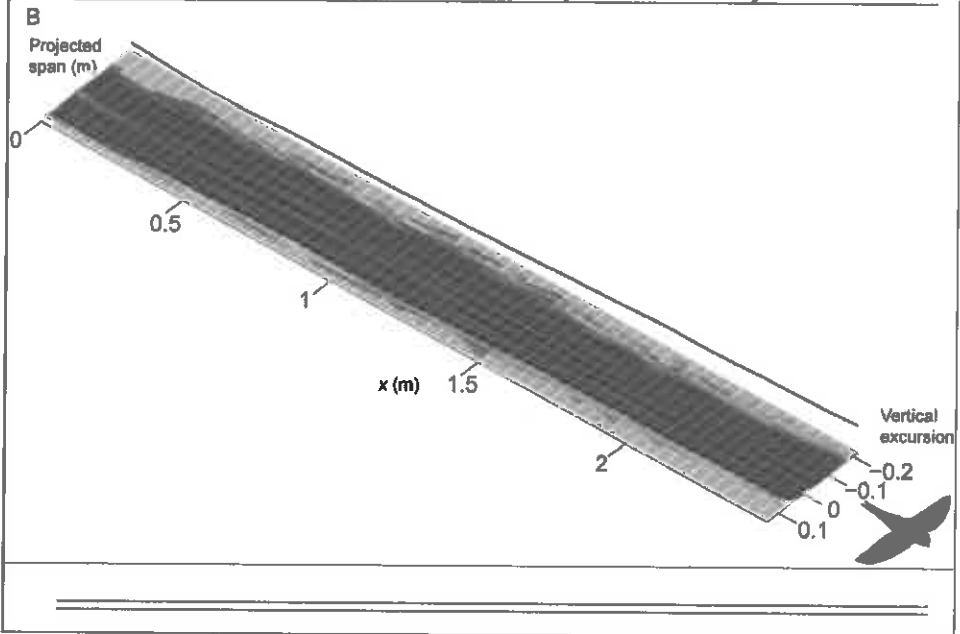

### Henningsson 2014 (PLOS One)

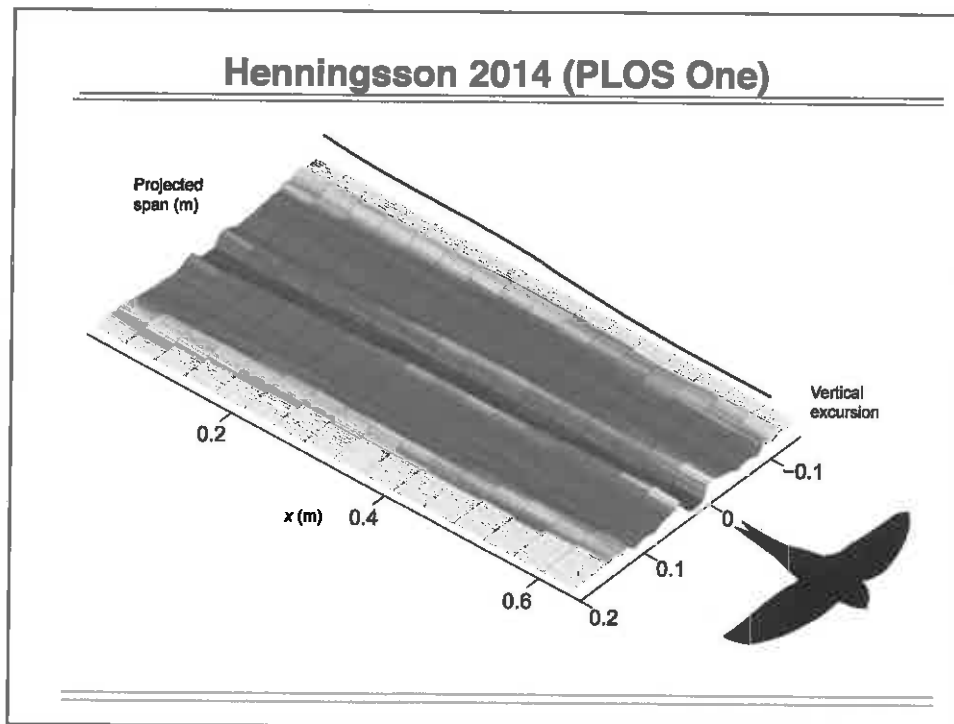

## Portugal, et al 2014 (Nature)

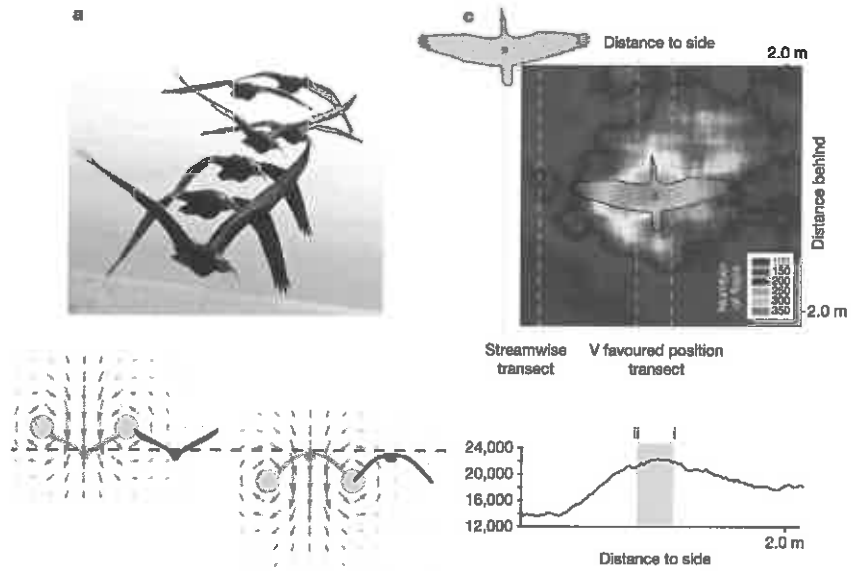

## Upwash and Wing Beats

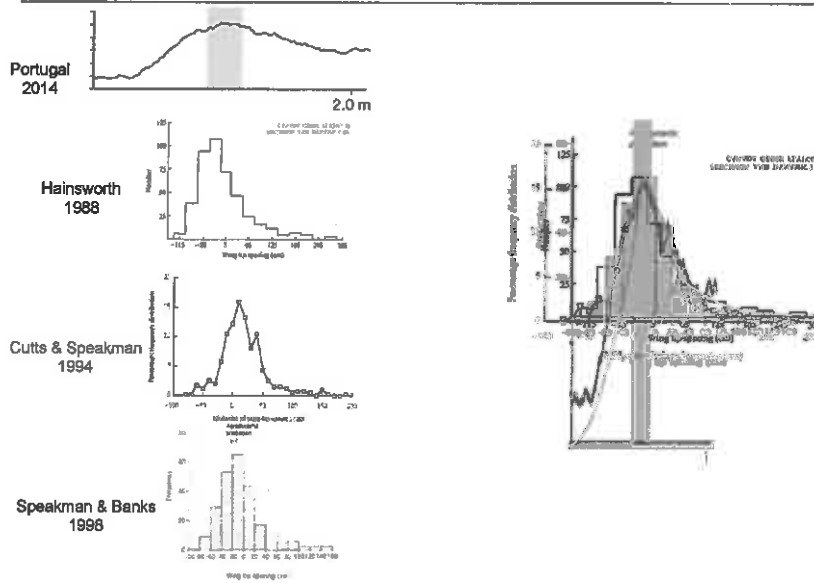

## Upwash and Wing Beats

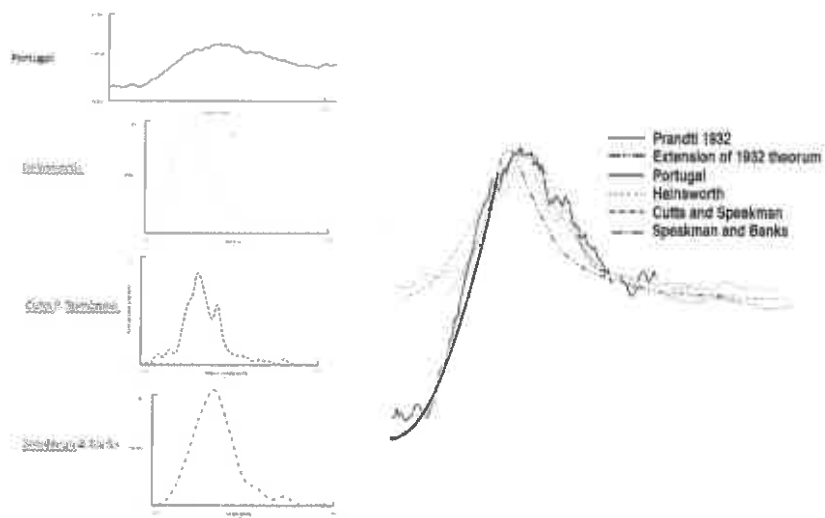

## Wing Stall

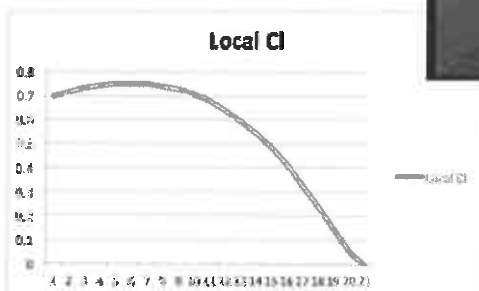

## Nachtigall 1966 (J of Exp Bio)

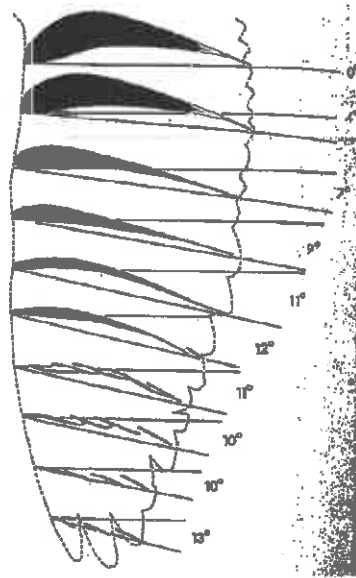

## Effect of Sideslip

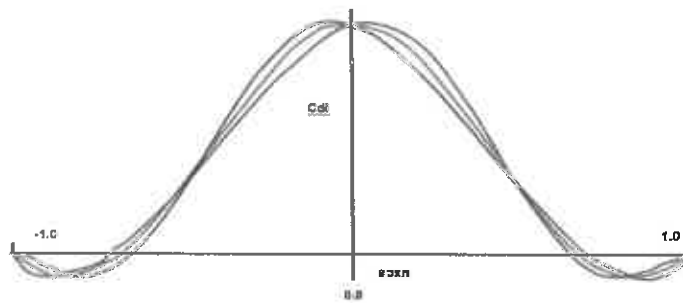

- Wing twist
- Sideslip is imposed
- Distorts the bell spanload and the induced drag/thrust profile



### PRANDTL-D Proverse Yaw?

What would Proverse Yaw look like?



## Flight Data

- Measurement of proverse yaw would be the final hurdle to achieve
- Icing on the cake: measure  $C_{nda}$  (yawing moment due to aileron deflection)
  
- **NOT ONE SECOND OF FLIGHT DATA EXISTS TO PROVE ANY OF THIS IS TRUE**

## Proverse Yaw

- ...until June 26<sup>th</sup>, 2013
- Roll and Yaw are the same sign
- From Uden:  $C_{nda}$  is +ve
- uncertainty

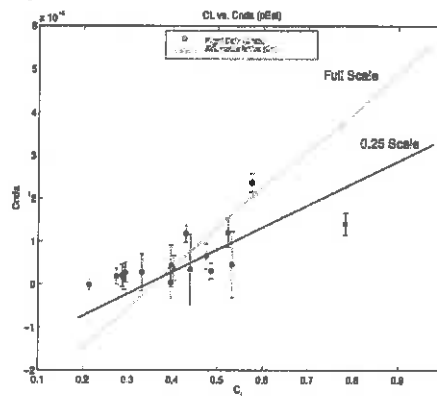
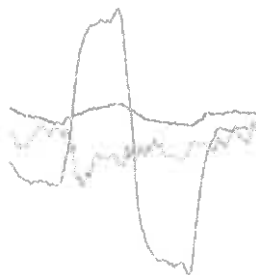

Inertias; configuration changes, turbulence, and slope of  $C_{nda}$

## PRANDTL-D Aircraft

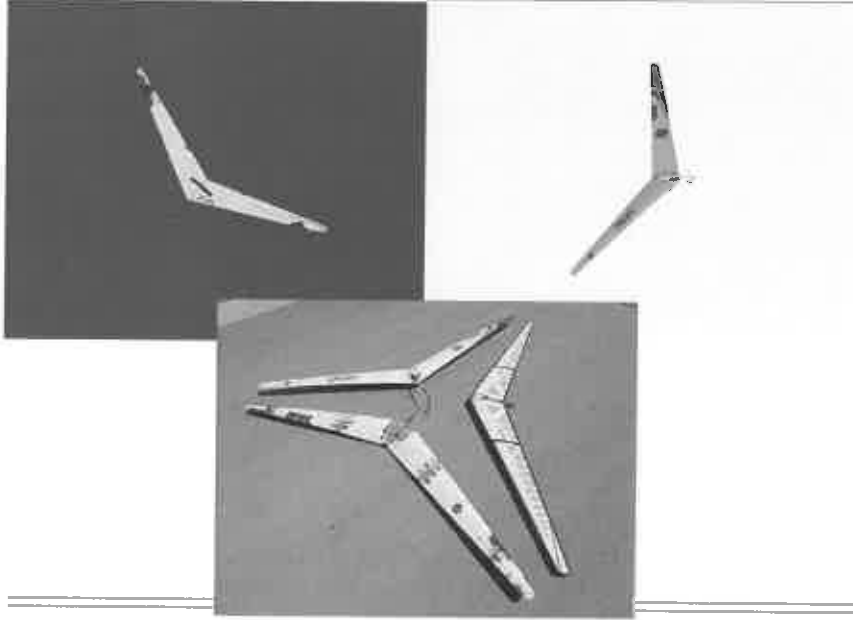

## Control of Yaw

- You Have Three Choices:



- 1/ drag a vertical tail around with you all the time to create a yawing moment
- 2/ manipulate drag at the wing tips to control yaw

} Current Design Options

-OR-

- 3/ manipulate THRUST at the wing tips to control yaw
- Biological vs Mechanical Flight



## Biological Flight

- Mechanical Flight (110 yrs)
- Vertebrate Flight (128 My)

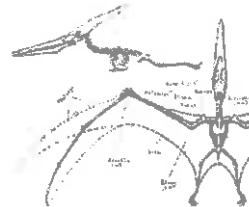

## Prandtl, Horten, Jones, and Birds

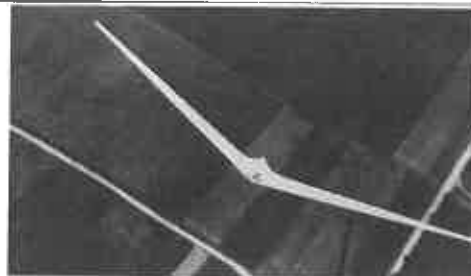
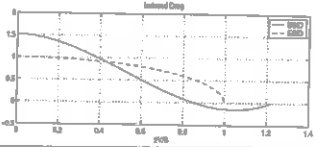
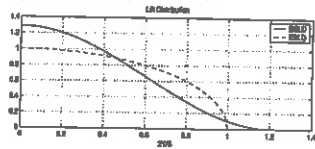
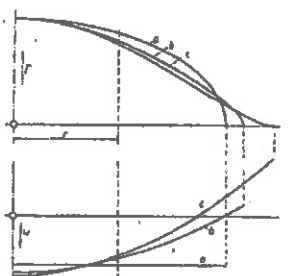

## Efficiency

---

- Efficiency: 12.5% increase in wing efficiency
  - 20-30% increase in efficiency by eliminating the tail
  - 15.4% increase in propulsive efficiency
  - TOTAL EFFICIENCY INCREASE: 69%
  
  - CY2011: world jet fuel consumption \$134B
  - \$55B in jet fuel saved
  
  - CY2011 World GDP: \$69.7T
  - World power production: \$12.0T
  - \$1.85T savings in world power production
- 

## Concluding Remarks

---

- Birds as the first model for flight
  - Applied approach gave immediate solutions, departure from bird flight
  - Eventual meeting of theory and applications (applied theory)
  - Spanload evolution (Prandtl/Horten/Jones/Klein/Viswanathan/Whitcomb/Bowers)
  - Solve performance, structure and control with ONE spanload solution!
  - 12.5% increase in L/D, ~2% increase in prop efficiency, 20-30% decrease in drag eliminating the tail, ~43-62% reduction in total aero efficiency
  - Assumptions and Solutions
  - The Wrights disintegrated the flight of birds, and Prandtl/Horten/Jones reintegrated the flight of birds...
  - Thanks: Red Jensen, Brian Eslinger, Dr Christian Gelzer, Dr Oscar Murillo, Hayley Foster & Steve Craft, Dr Bob Liebeck, Nalin Ratnayake, Mike Allen, Walter Horten, Georgy Dez-Falvy, Rudi Opitz, Bruce Carmichael, R.T. Jones, Russ Lee, Bob Hoey, Phil Barnes, Dan & Jan Armstrong, Dr Phil Burgers, Ed Lockhart, Andy Kesckes, Dr Paul MacCreedy, Reinhold Stadler, Dr Edward Uden, & Dr Karl Nickel
-

## NASA Aero Academies & Others

- 2014 NASA Aero Academy  
- Brian Plank, Joe Lorenzetti, Kathleen Glasheen, Bryce Doerr, Cynthia Farr, Nancy Pinon, Heather Laffoon, Jack Toth, Leo Banuelos
- 2013 NASA Aero Academy  
- Eric Gutierrez, Louis Edelman, Kristyn Kadala, Nancy Pinon, Cody Karcher, Andy Putch, Hovig Yaralian, Jacob Hall
- 2012 NASA Aero Academy  
- Steffi Valkov, Juliana Plumb (Ulrich), Luis Andrade, Stephanie Reynolds, Joey Wagster, Kimmy Callan, Javier Rocha, Sanel Horozovic, Ronalynn Ramos, Nancy Pinon
- Mike Allen, Alex Stuber, Matt Moholt, Dave Voracek, Jaiwon Shin, Ross Hathaway, Brian Eslinger, Oscar Murillo, Lesli Monforton, Red Jensen, Aamod Samuel, Brad Neal, Brad Flick, Chris Acuff, Rick Howard (NPS), Marko Stamenovic, Jim Murray, Nalin Ratnayake, Eric Nisbet, Jeromy Robbins, Nelson Brown, Curtis Stump, Andrew Burrell, Anthony MacPherson, Brian Taylor, Chris Miller, Victor Loera, Cameron Law, Koen vander Kerckhove, Bob Hoey, Russ Lee, Reinhold Stadler, Edward Uden, Paul MacCready, Karl Nickel, Walter Horten, Diego Roldan Knollinger, Michael Cox, Jeff Jennings, Phil Barnes

## References

- Anderson, John Jr: "A History of Aerodynamics: and Its Impact on Flying Machines"; Cambridge University Press; Cambridge, United Kingdom.
- Prandtl, Ludwig: "Applications of Modern Hydrodynamics to Aeronautics"; NACA Report No. 116; 1921.
- Munk, Max M.: "The Minimum Induced Drag of Aerofolls"; NACA Report No. 121, 1923.
- Nickel, Karl; and Wohlfart, Michael; with Brown, Eric M. (translator): "Tailless Aircraft in Theory and Practice"; AIAA Education Series, AIAA, 1994.
- Prandtl, Ludwig: "Über Tragflügel Kleinsten Induzierten Widerstandes"; Zeitschrift für Flugtechnik und Motorluftschiffahrt, 28 XII 1932; München, Deutschland.
- Horten, Reimar; and Selinger, Peter; with Scott, Jan (translator): "Nurflügel: the Story of Horten Flying Wings 1933 - 1960"; Weishapt Verlag; Graz, Austria; 1985.
- Horten, Reimar; unpublished personal notes.
- Uden, Edward; unpublished personal notes.
- Jones, Robert T.; "The Spanwise Distribution of Lift for Minimum Induced Drag of Wings Having a Given Lift and a Given Bending Moment"; NACA Technical Note 2248, Dec 1950.
- Klein, Armin and Viswanathan, Sathy; "Approximate Solution for Minimum Induced Drag of Wings with a Given Structural Weight"; Journal of Aircraft, Feb 1975, Vol 12 No 2, AIAA.
- Whitcomb, R.T.; "A Design Approach and Selected Wind Tunnel Results at High Subsonic Speeds for Wing-Tip Mounted Winglets," NASA TN D-8260, July 1976.
- Jones, Robert T.; "Minimizing Induced Drag."; Soaring, October 1979, Soaring Society of America.
- Koford, Carl; "California Condor"; Audobon Special Report No 4, 1950, Dover, NY.
- Hoey, Robert; "Research on the Stability and Control of Soaring Birds"; AIAA Report 92-4122-CP, AIAA, 1992
- Lee, Russell; "Only the Wing: Reimar Horten's Epic Quest to Stabilize and Control the All-Wing Aircraft," Smithsonian Institution Scholarly Press (Rowman & Littlefield), Washington D.C., 2011.
- Spedding, G. R., The wake of a kestrel (*falco tinnunculus*) in gliding flight, *J. exp. Biol.*, **127**, 45-57 (1987).
- Portugal, S. J. et al., Upwash exploitation and downwash avoidance by flap phasing in ibis formation flight, *Nature* **505**, 399-402 (2014).



NASA Aero Academy 2014

NASA Aero Academy 2013

NASA Aero Academy 2012

## PRANDTL-D

- Videos

- TEDxNASA 2011

<http://www.youtube.com/watch?v=223OmaQ9uLY>

- NASA Aero Academy 2013

<http://www.youtube.com/watch?v=Hr0I6wBFGpY>

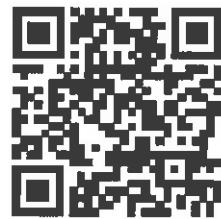

Red Jensen: pilot,  
engineer





If you want to build a ship, don't drum up people to collect wood and don't assign them tasks and work, but rather teach them to long for the endless immensity of the sea...

- *Antoine de Saint-Exupery*

---

---



**Questions?**

