

S7012



RAVEN RQ-11

PlyWood 2m.m.

PlyWood 3m.m.

LWF4

LWF3

LWF2

LWF1

5mm Block

2mm



FLR-11

TOP F-11

Door Frame Ply 2m.m.

F-4

F-5

F-6

F-7

Balsa 1m.m.

PLYWOOD 2m.m.

FC-8

F-4B

F-5B

F-11

FC-7

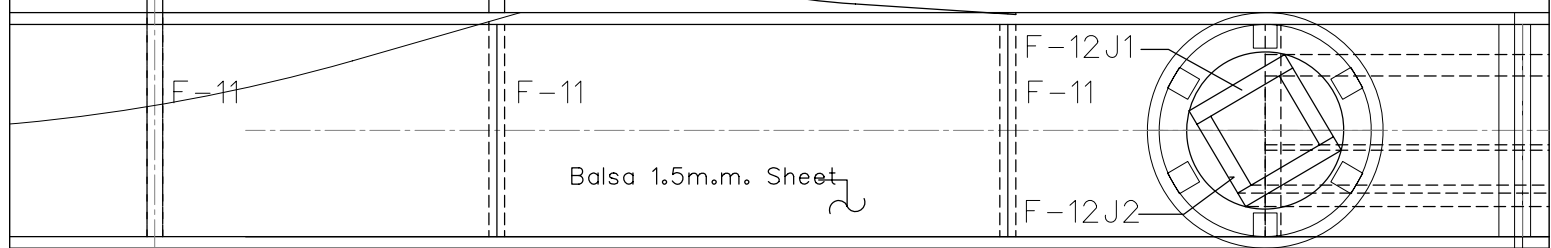
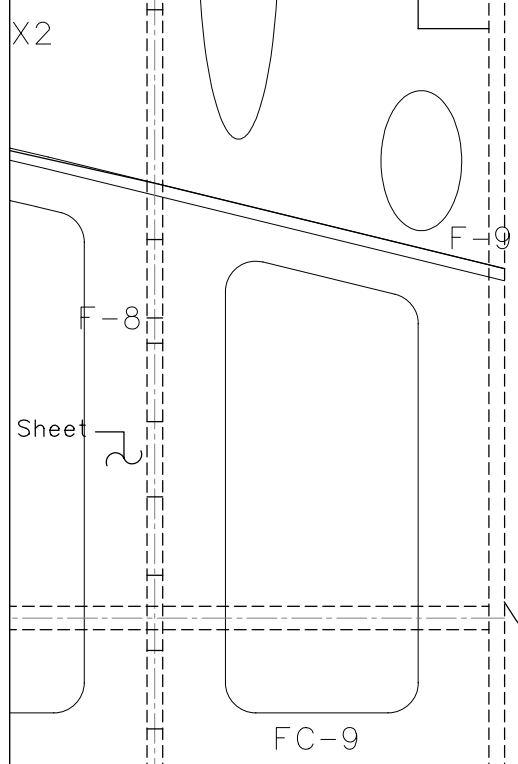
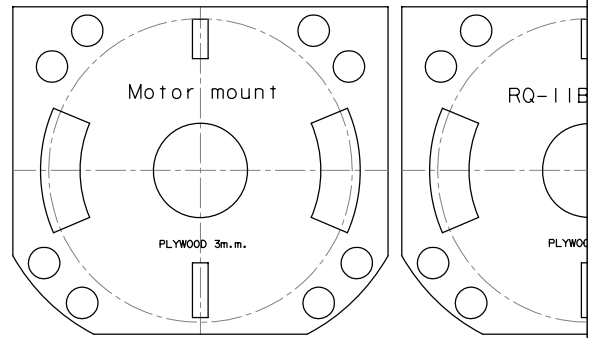
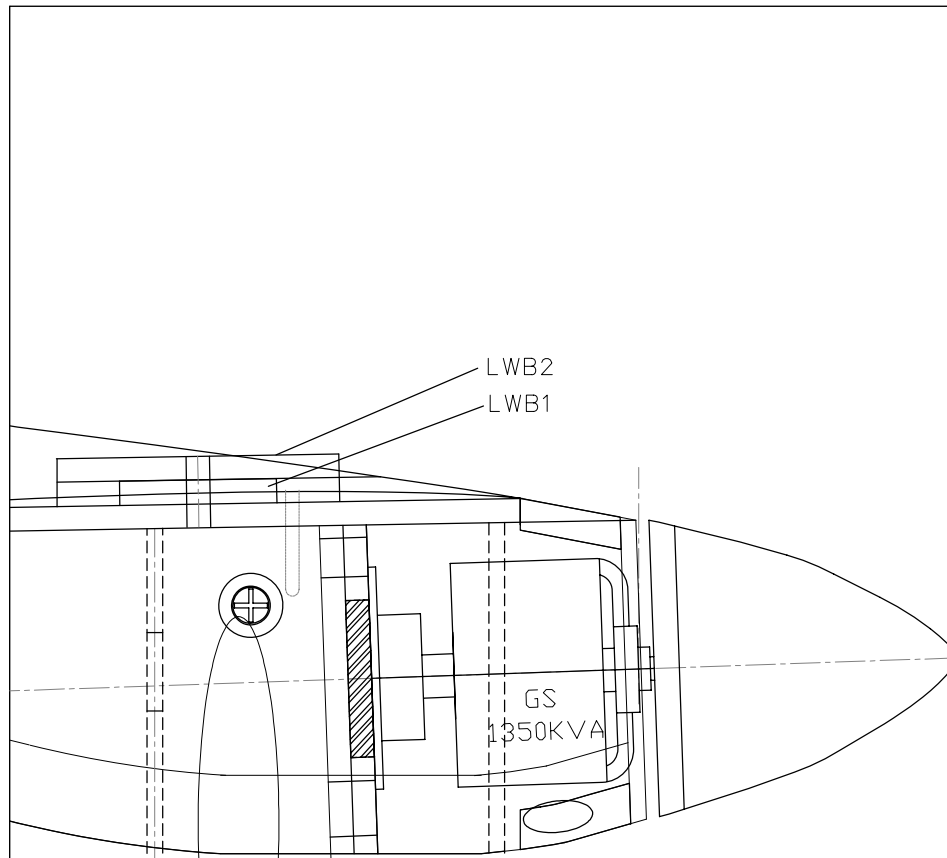

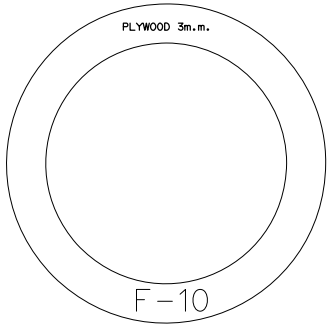
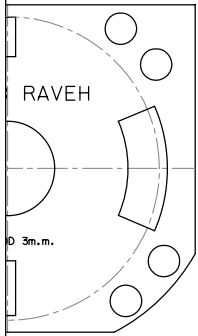

-12

F-12

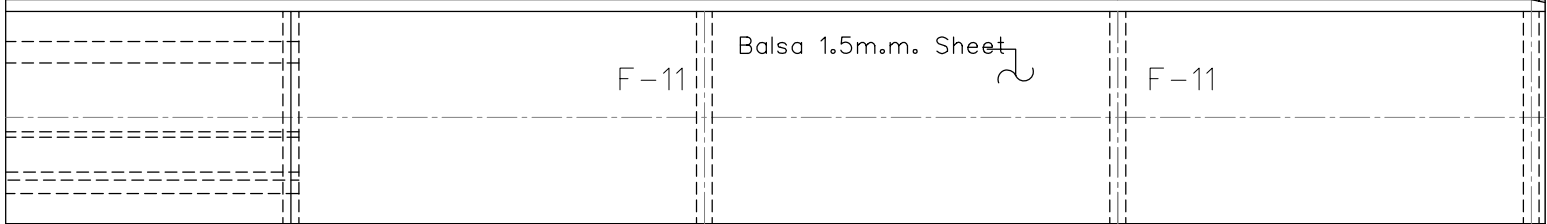

RUDDER MOVEMENT 19m.m. SIDE TO SIDE

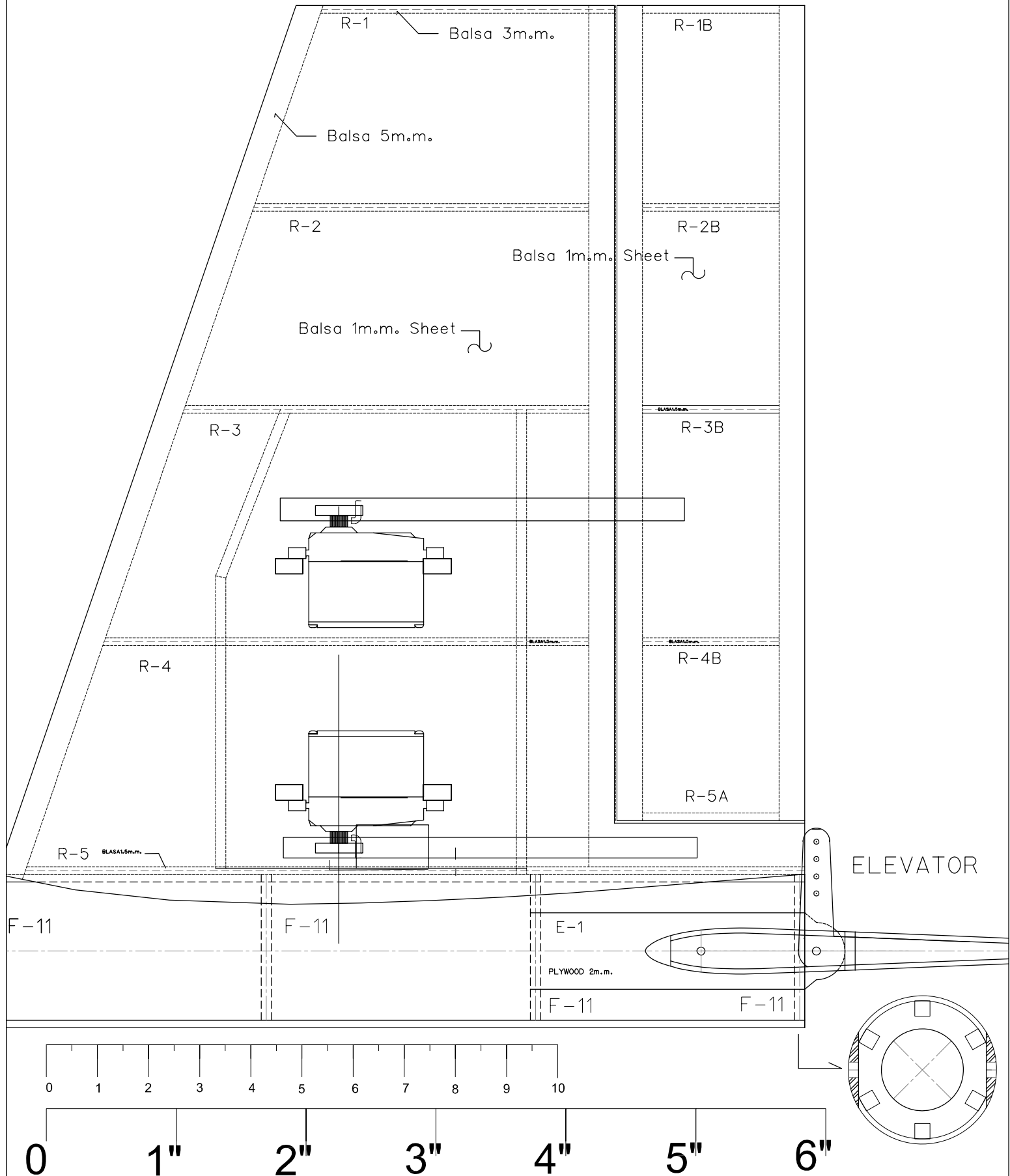

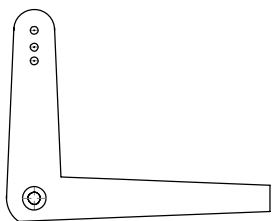
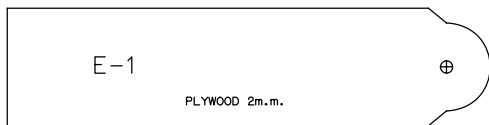
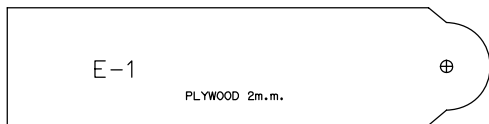
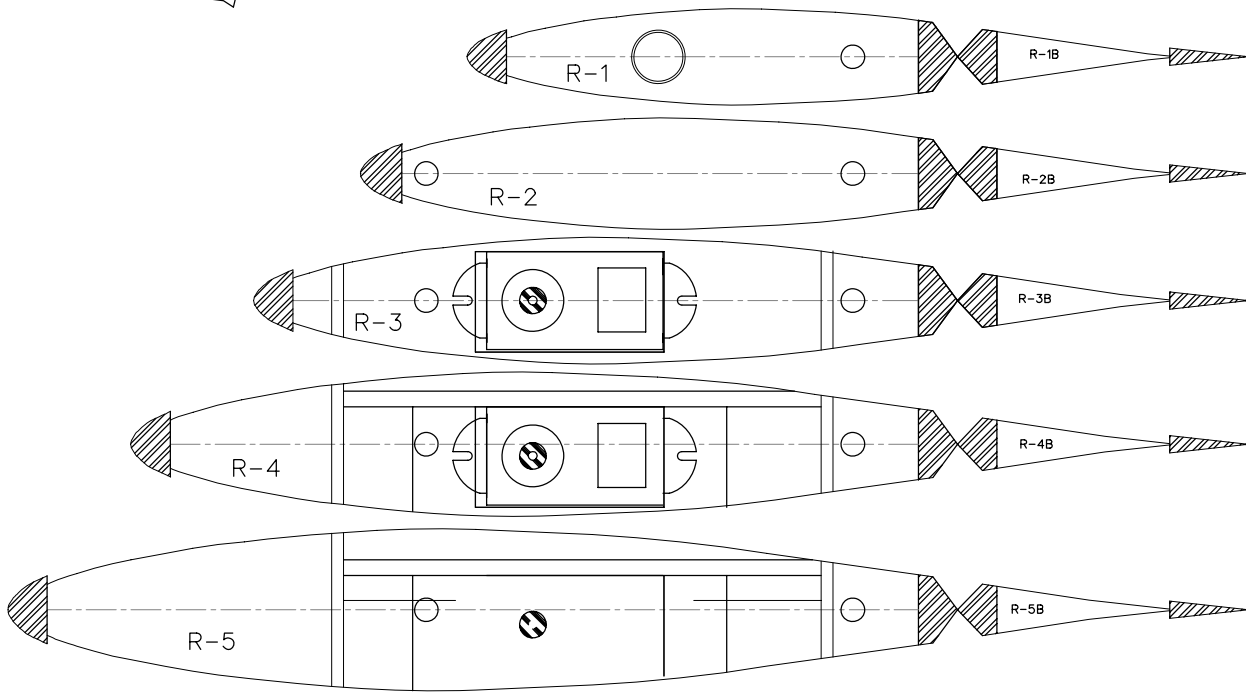

MOVEMENT 28 m.m. UP & DOWN

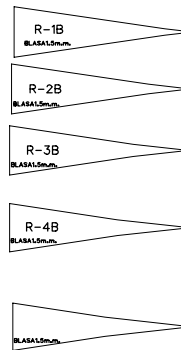

R.C. FLYING Radio Control
THE MOST EXCITING HOBBY & SPORT

RQ-11B RAVEN

FPV THAILAND

WWW.RCTHAI.NET

สำนักวิทยบริการ

DESIGNED: Mr.Chalernpol Hamhunsu

เฉลิมพล เทมพรธชา

hs7ei@hotmail.com

WINGSPAN 1290.5m.m.

WING AREA 413.5SQ.IN

LENGTH 1039.4m.m.

POWER MOTOR GS 1350kv SIZE 450

RADIO 3 CHANNEL

WEIGHT 1300g

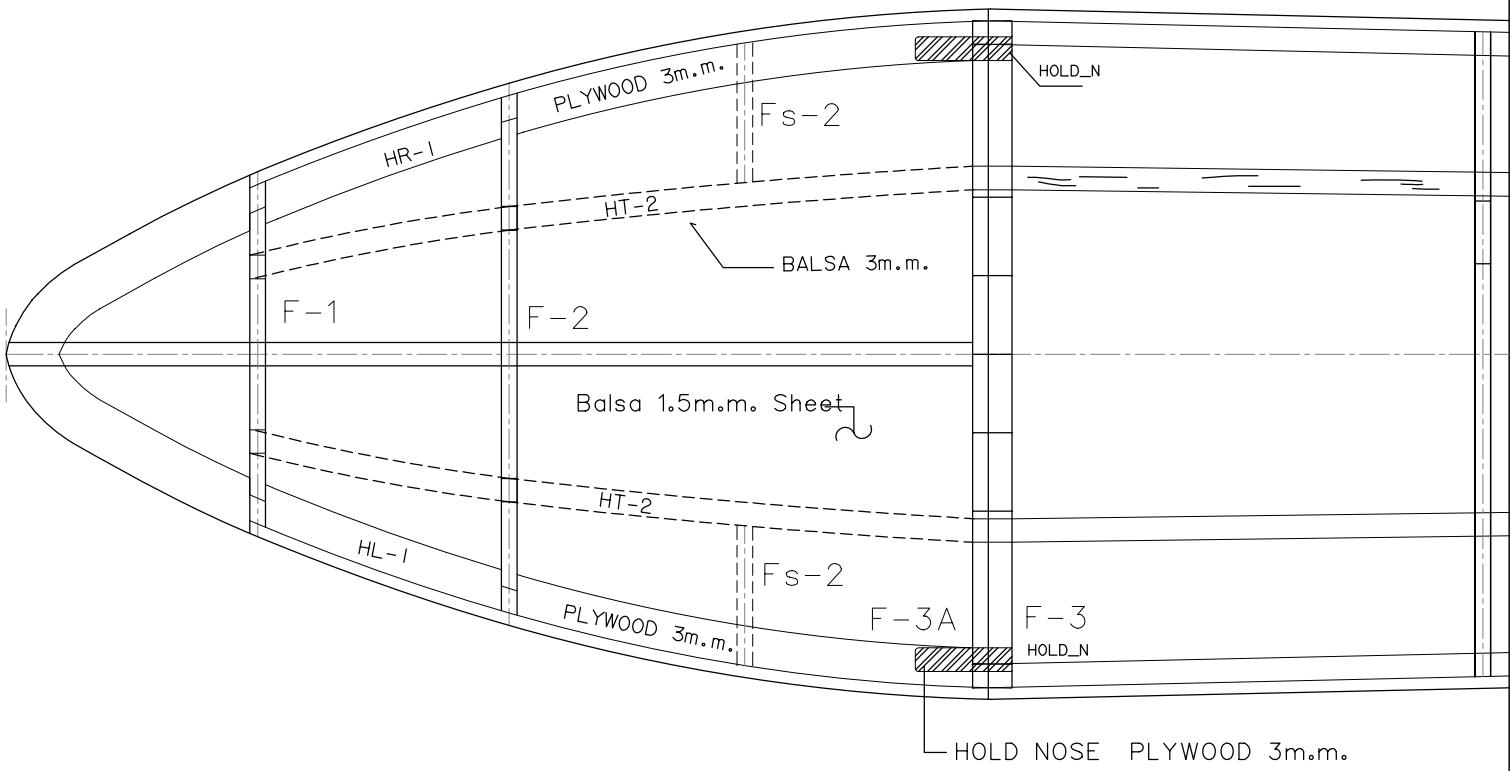

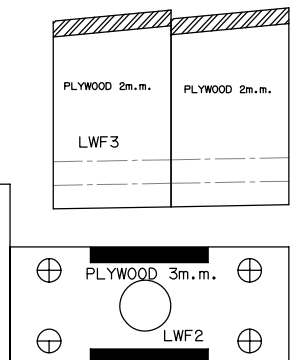
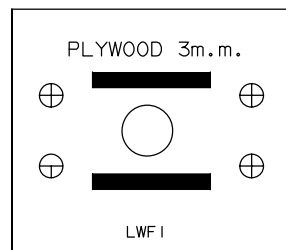
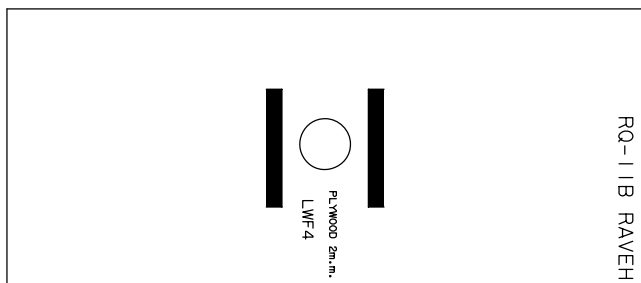
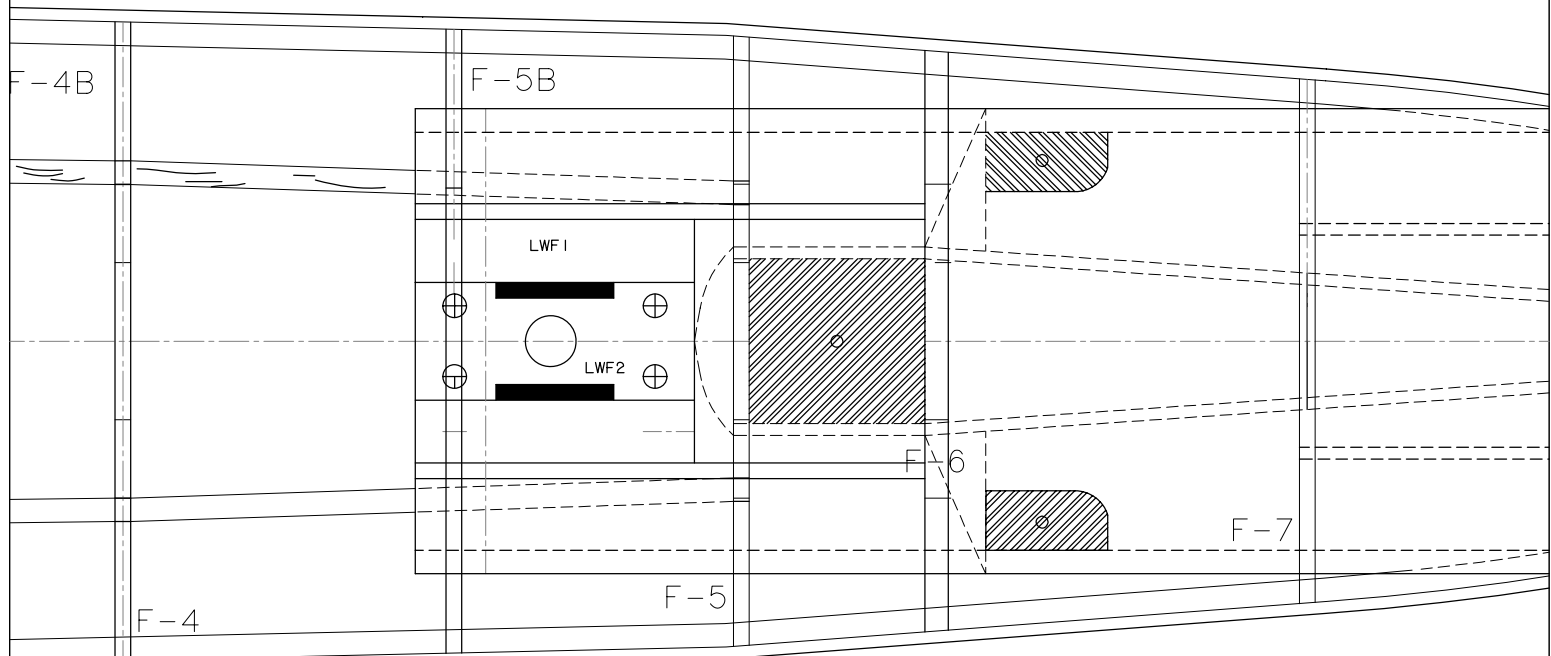
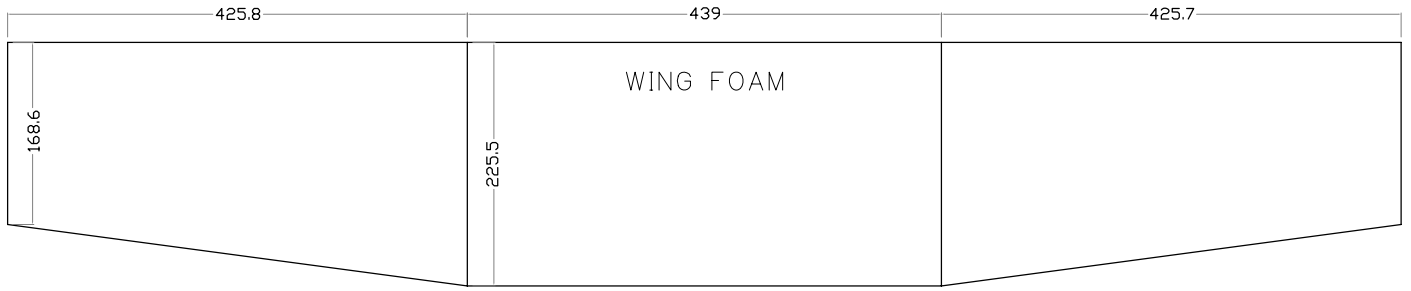

PLYWOOD 2m.m.

FLR-11
Balsa 3m.m. Sheet

Balsa 3m.m. Sheet
FLR-11

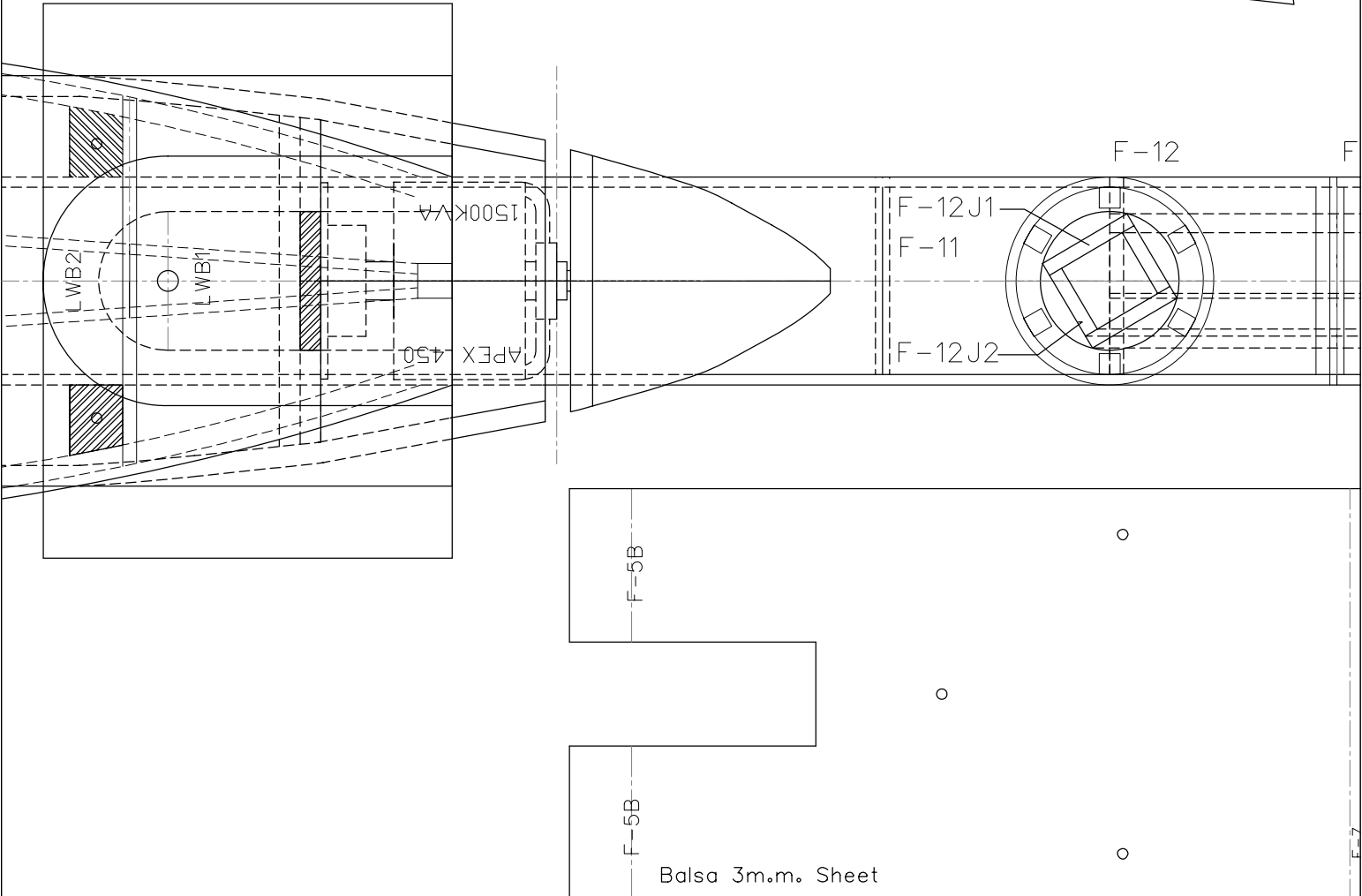

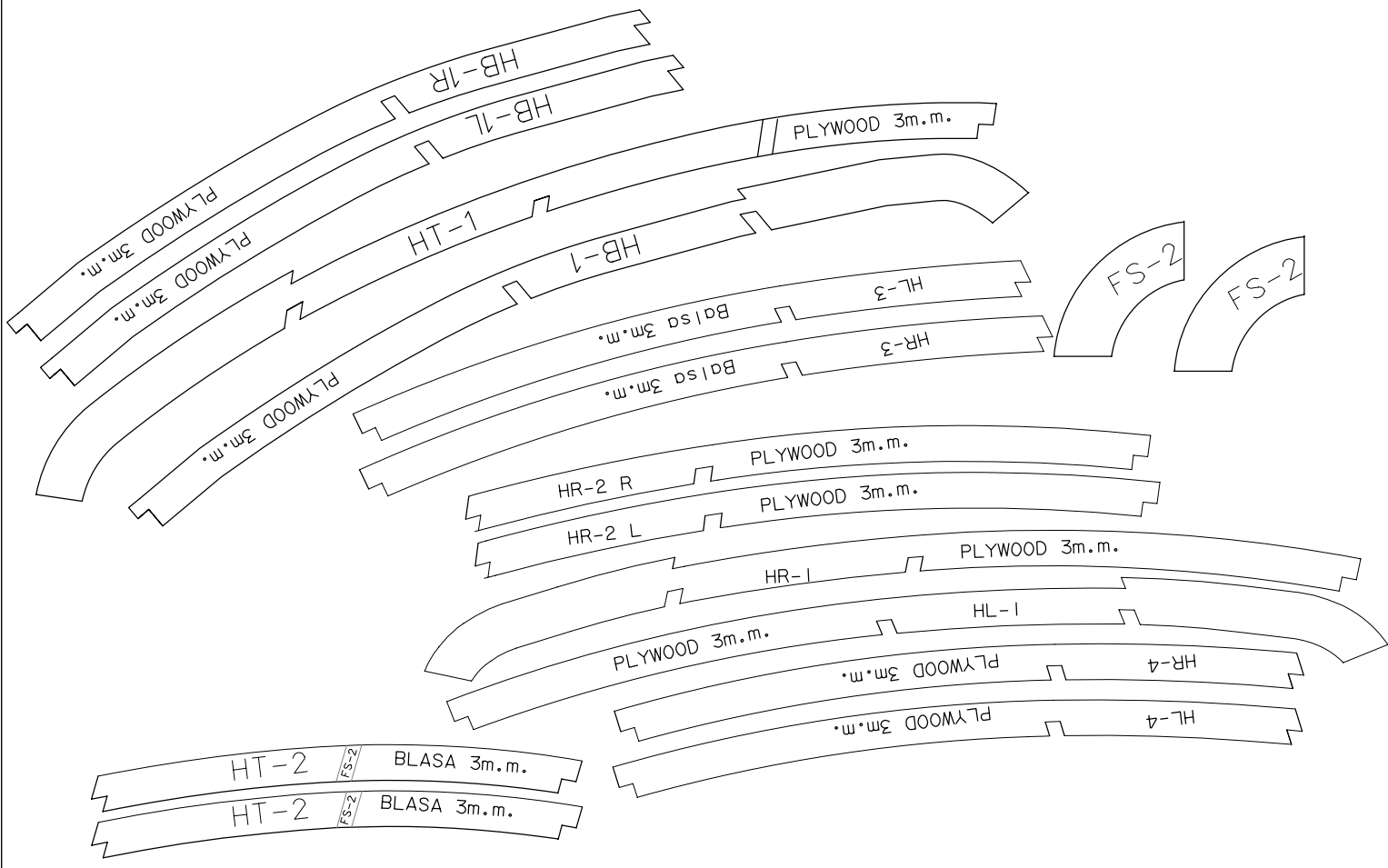

-12 F-12

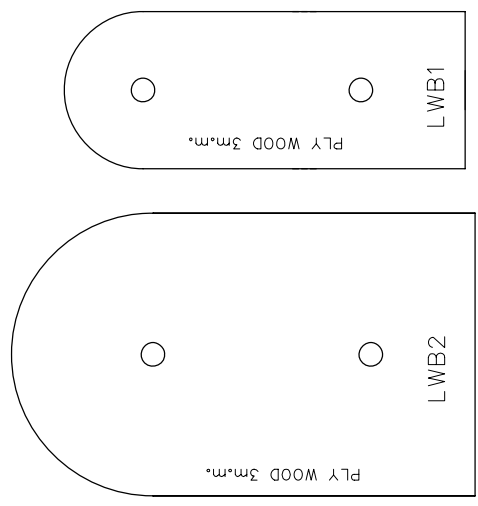
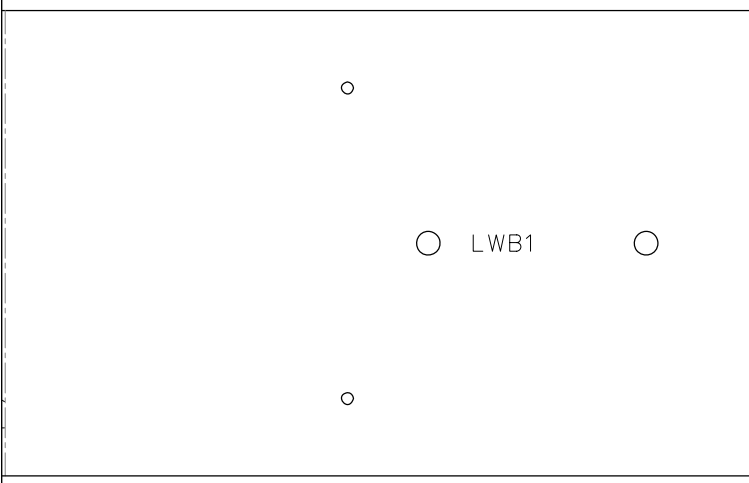
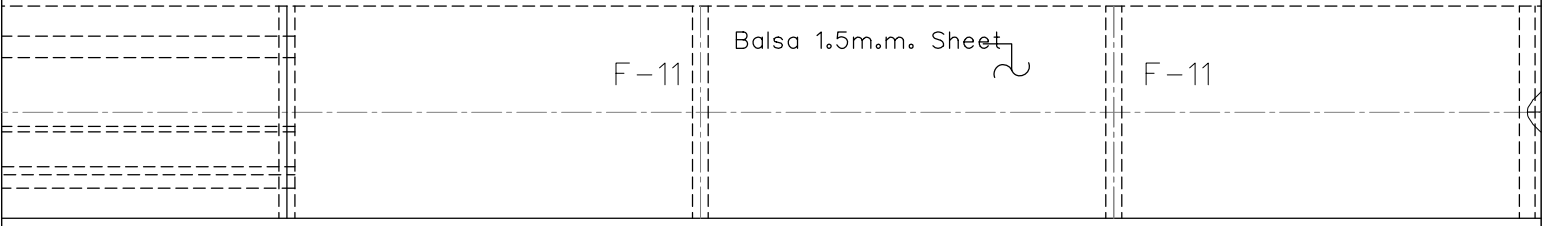

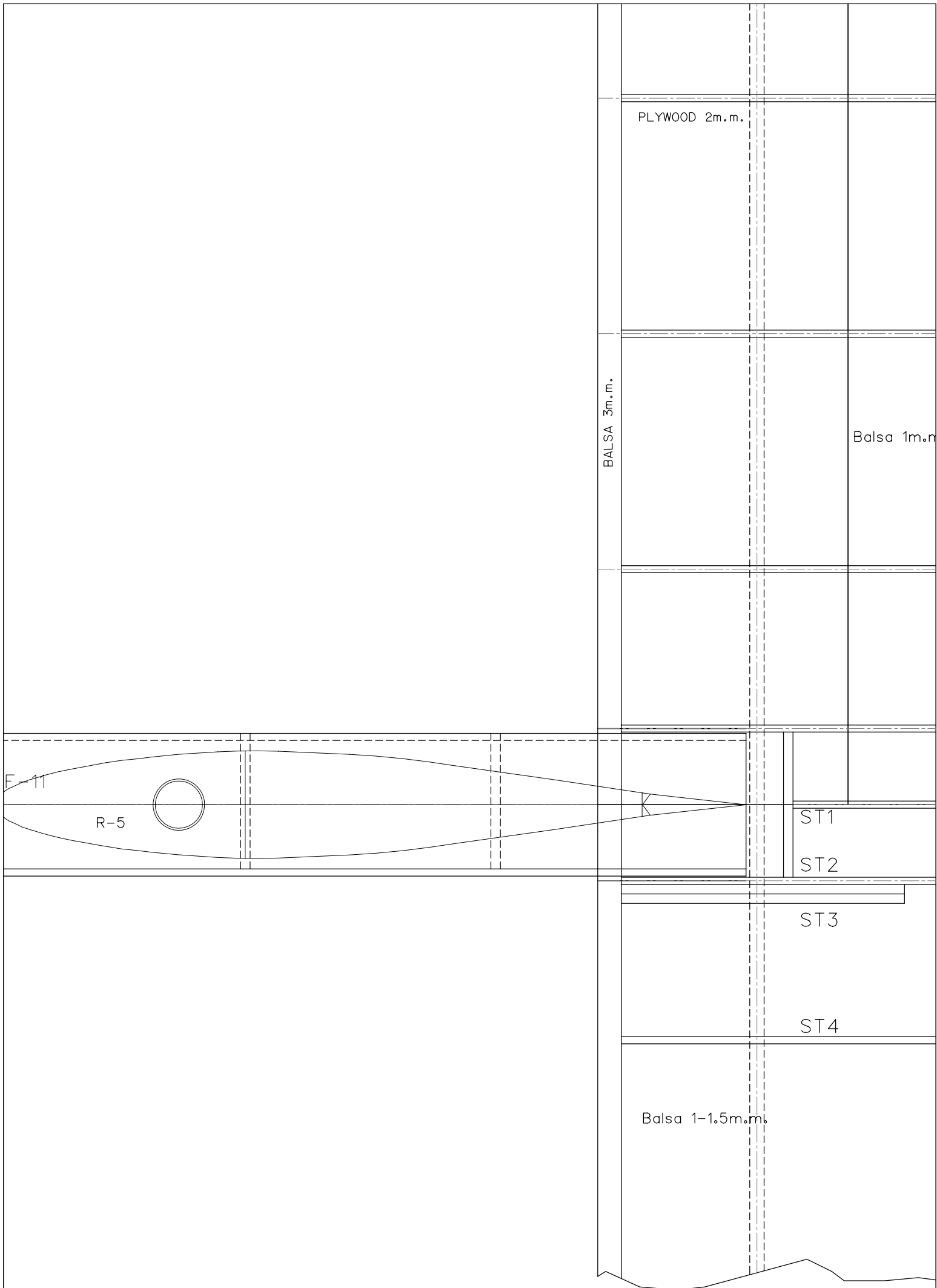

PLYWOOD 2m.m.

BALSA 3m.m.

Balsa 1m.m.

F-11

R-5

ST1

ST2

ST3

ST4

Balsa 1-1.5m.m.

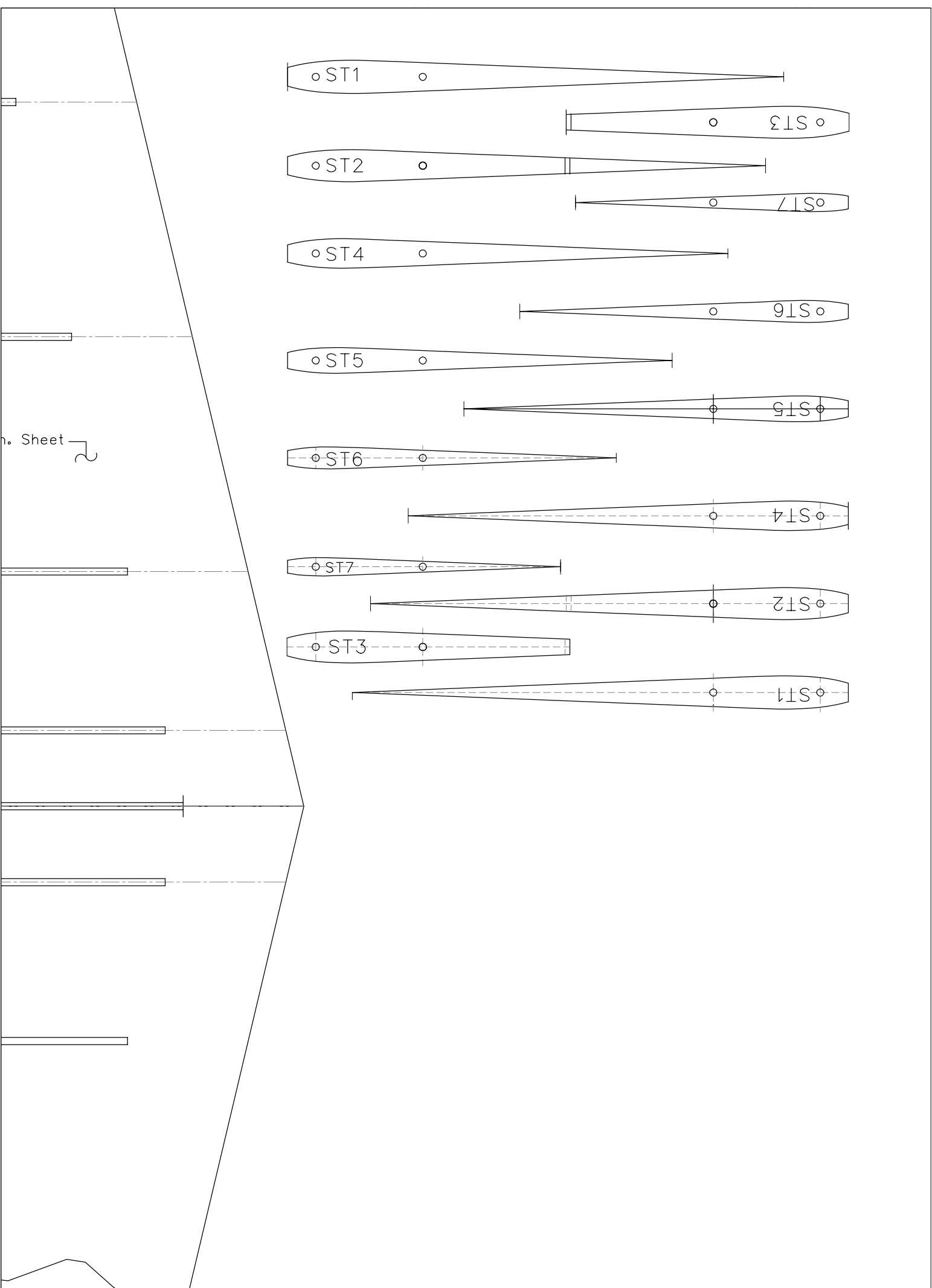

ST1

ST3

ST2

ST7

ST4

ST6

ST5

ST5

ST6

ST4

ST7

ST2

ST3

ST1

h. Sheet

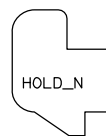
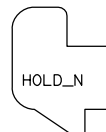
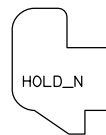
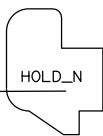
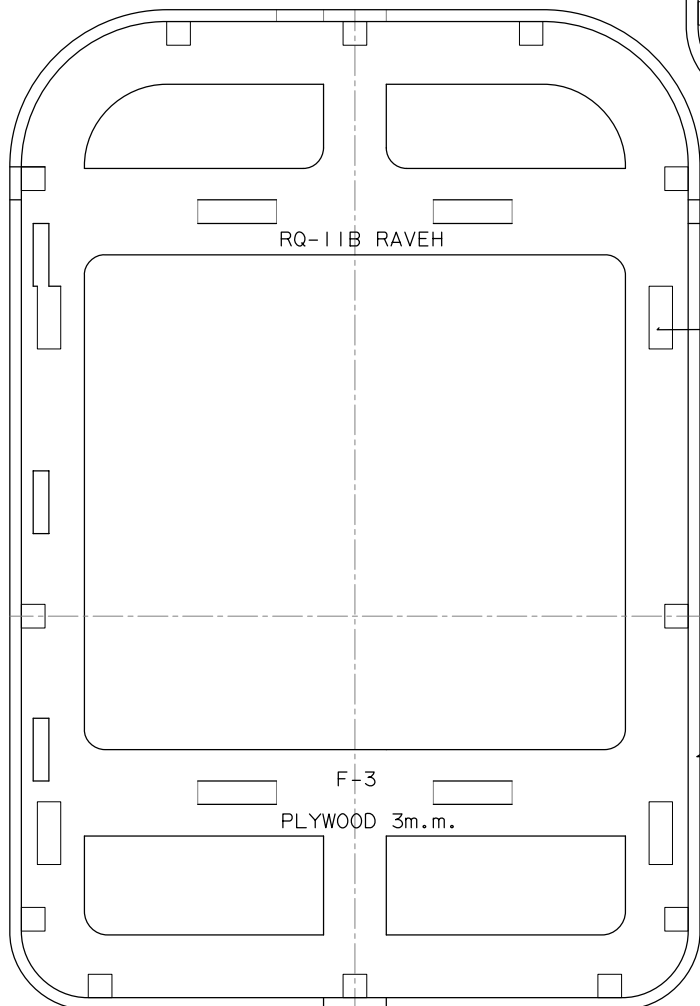
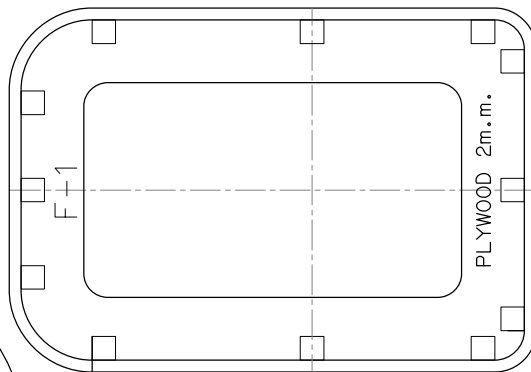
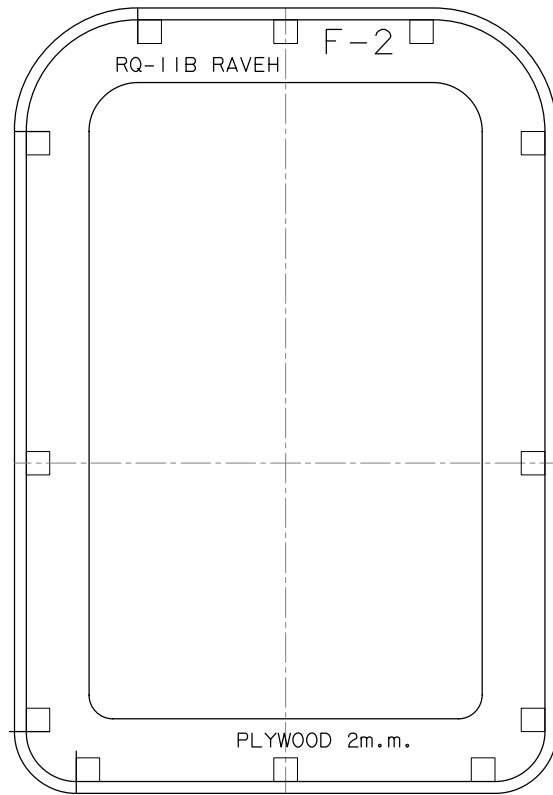
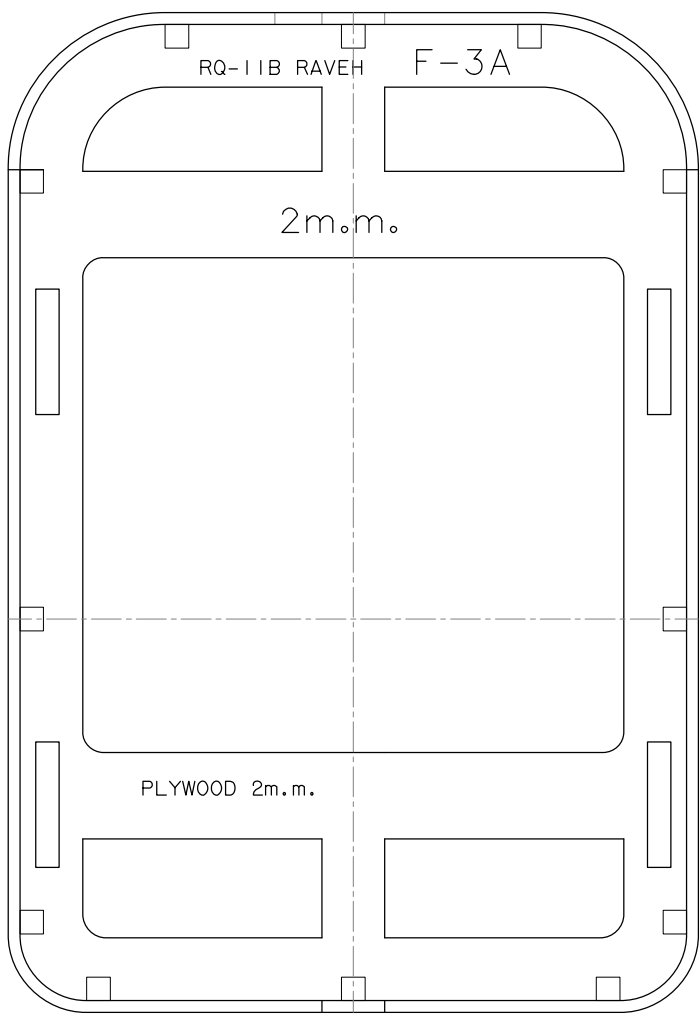

PLYWOOD 3m.m.

HOLD NOSE PLYWOOD 3m.m.

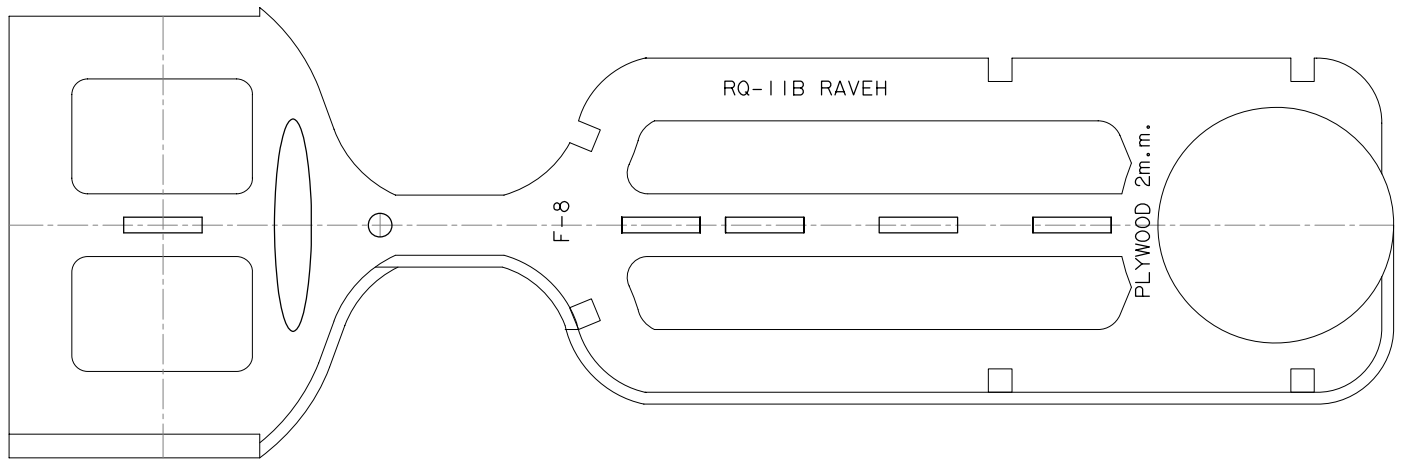
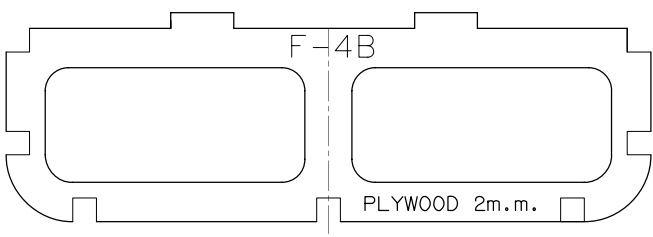
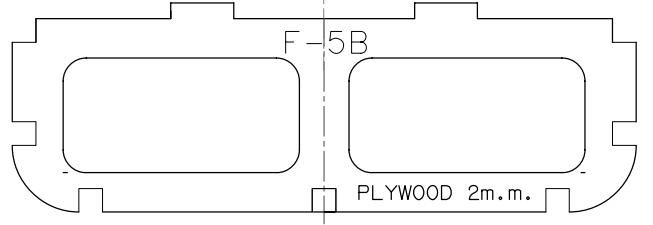
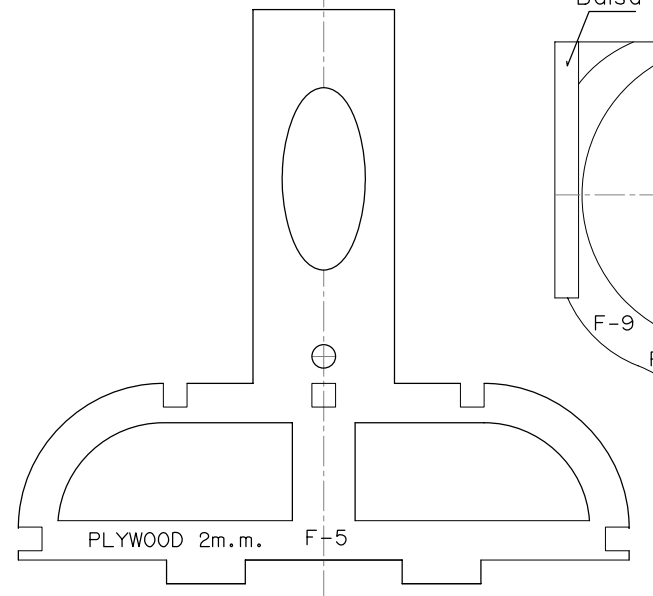
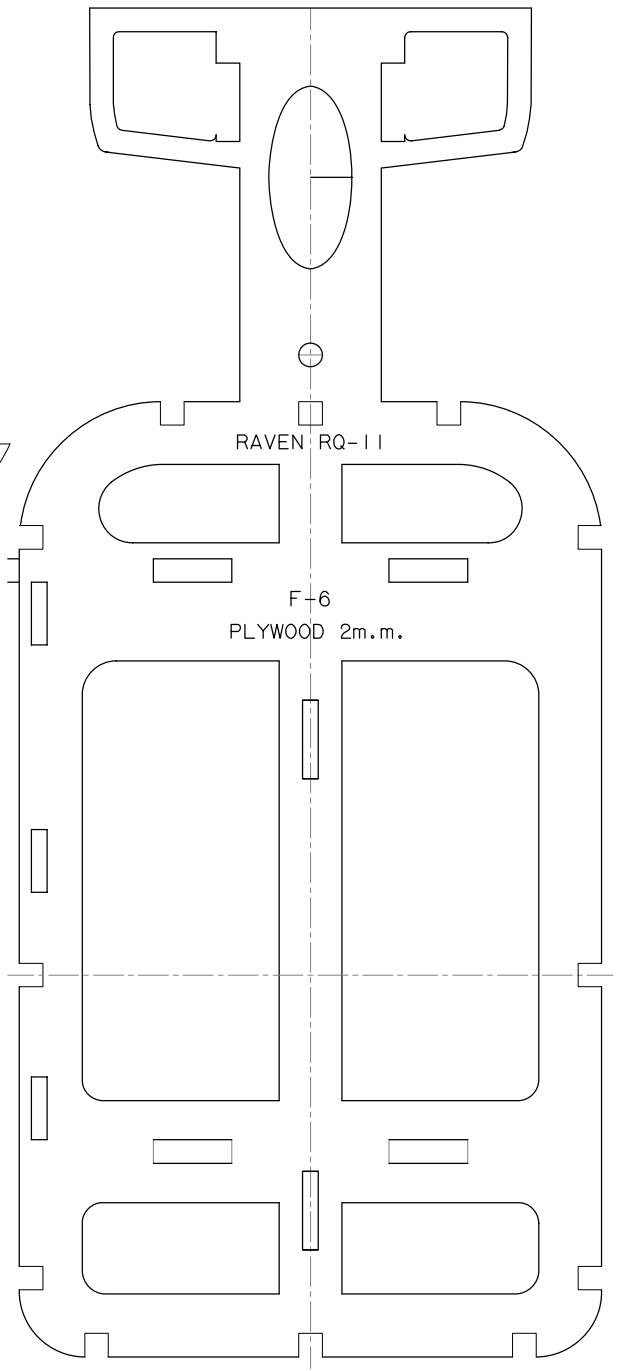
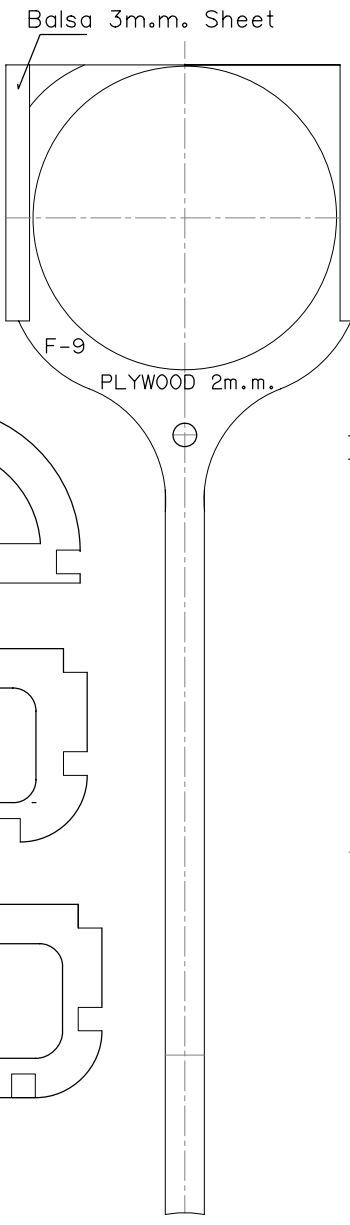
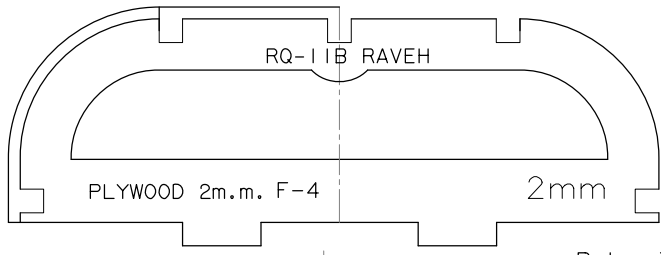

Balsa 3m.m. Sheet

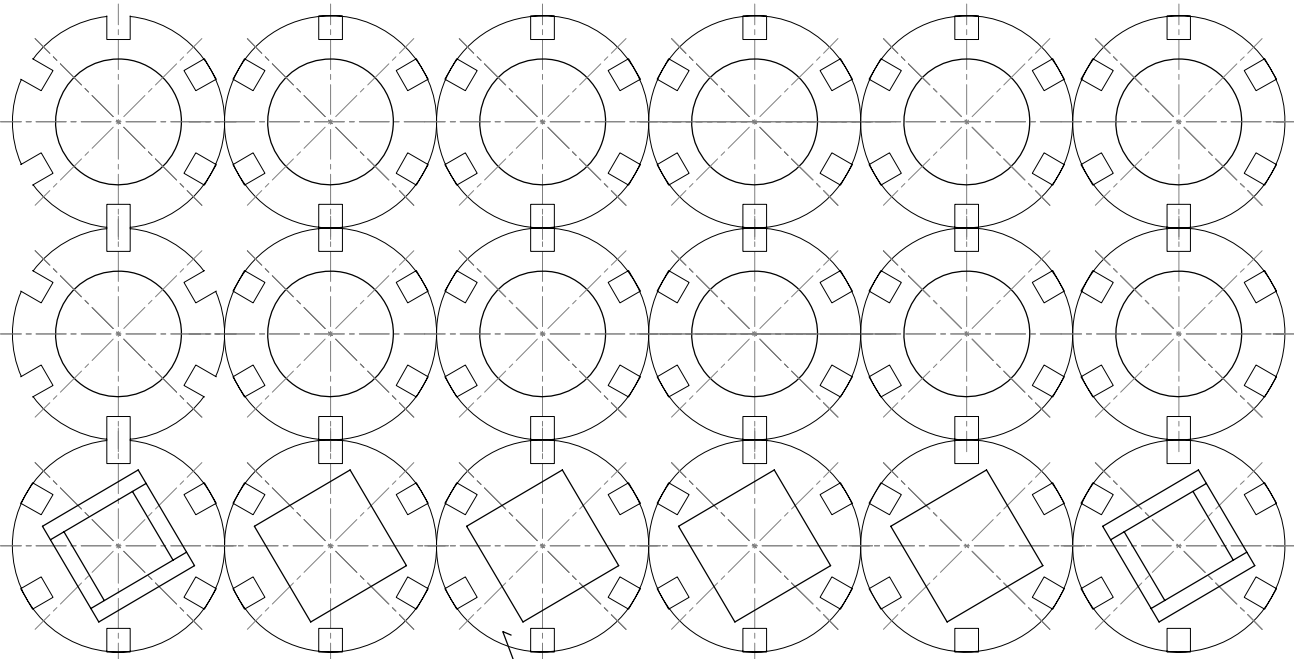
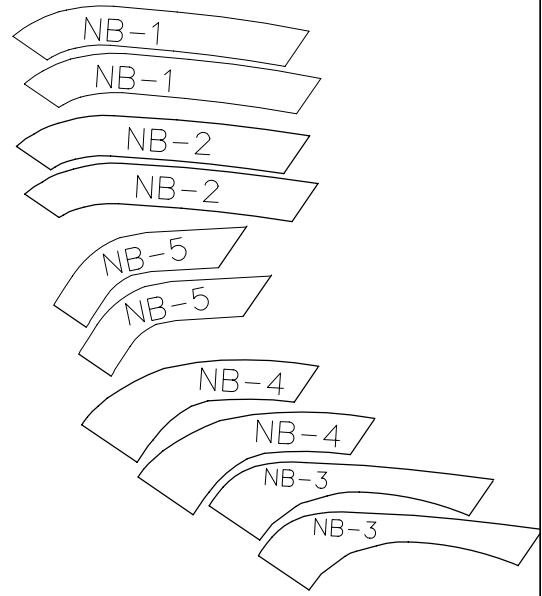
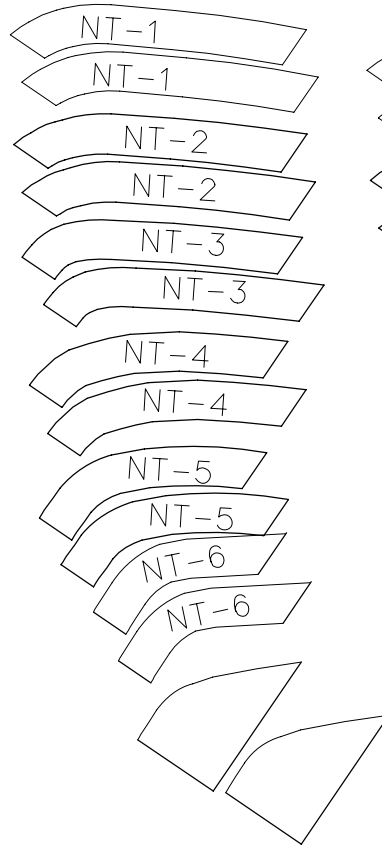
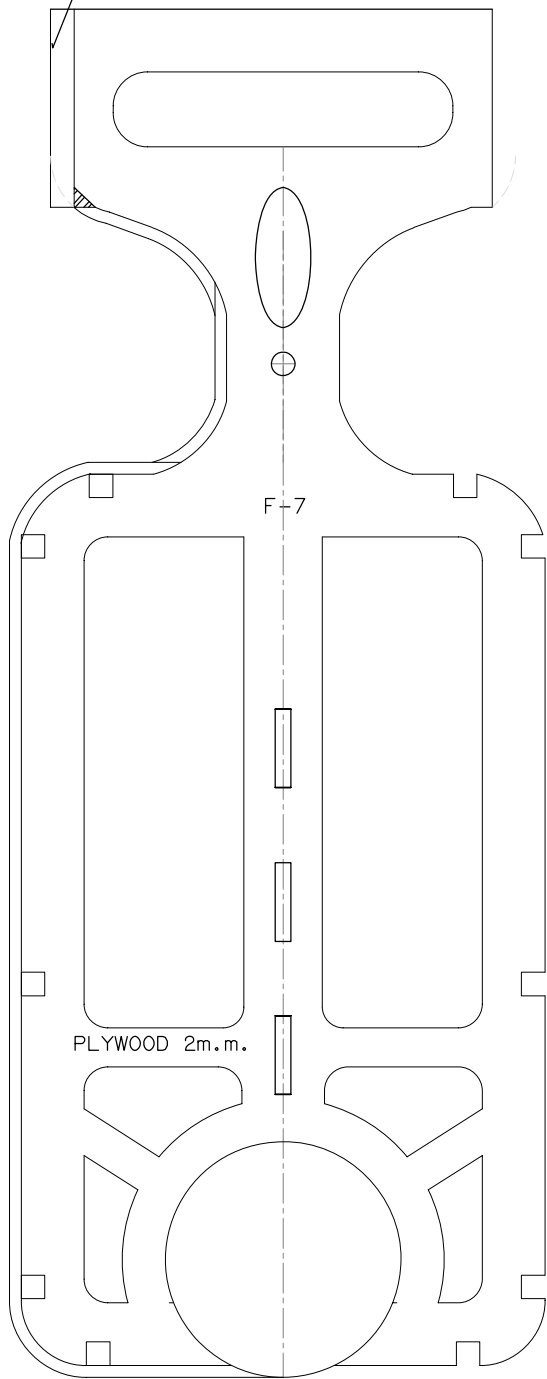

| |
|------------|
| C-3 PLY2mm |
| C-2 PLY2mm |
| C-2 PLY2mm |

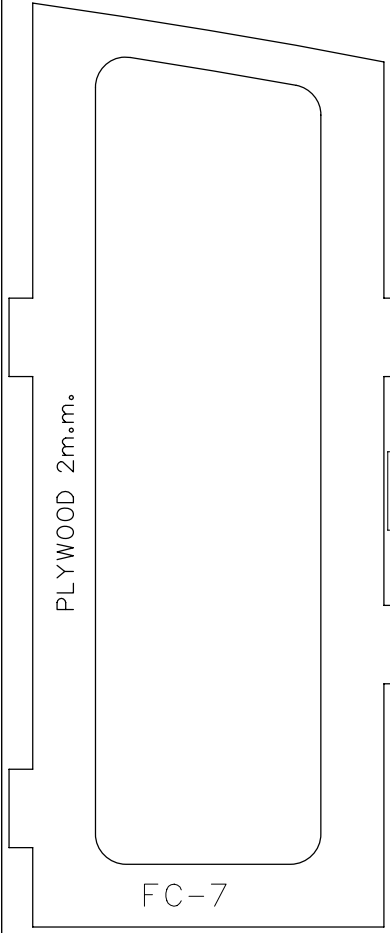
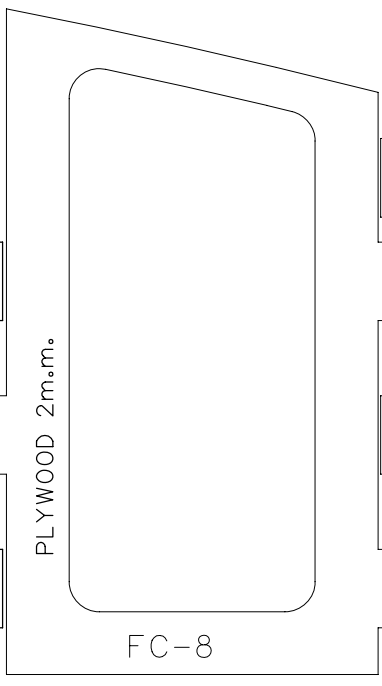
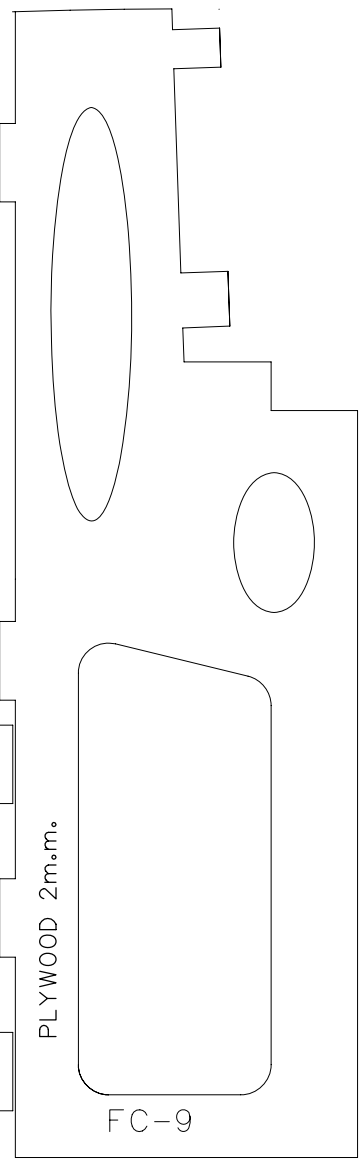
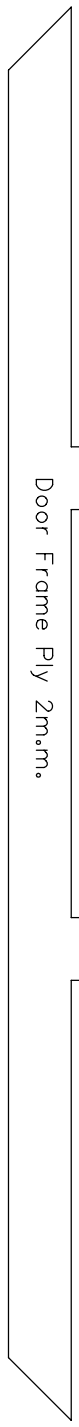
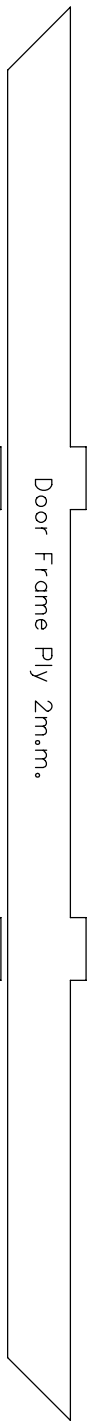
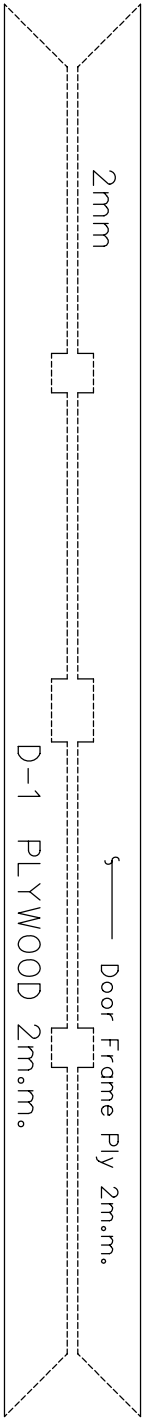
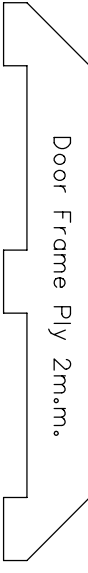
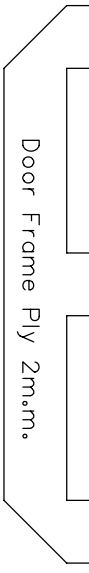

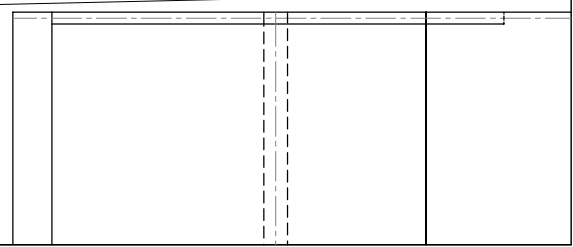
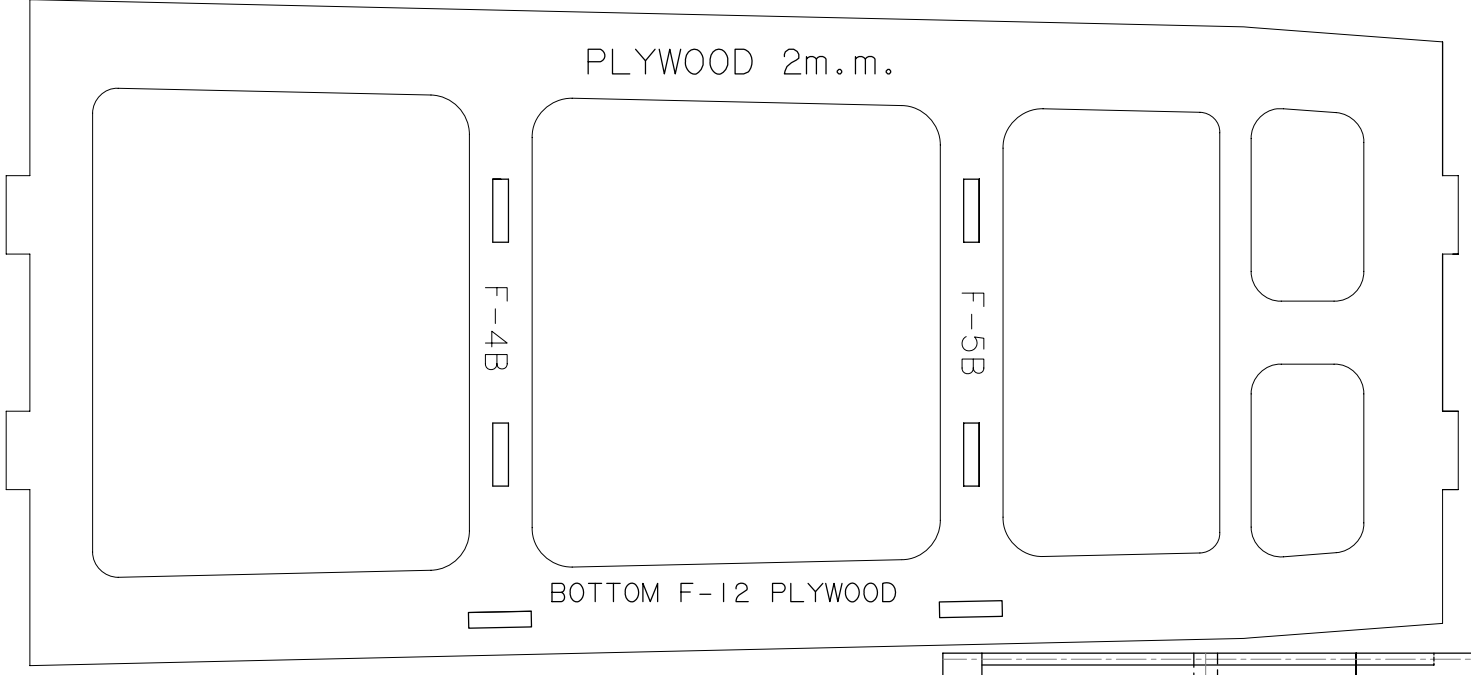
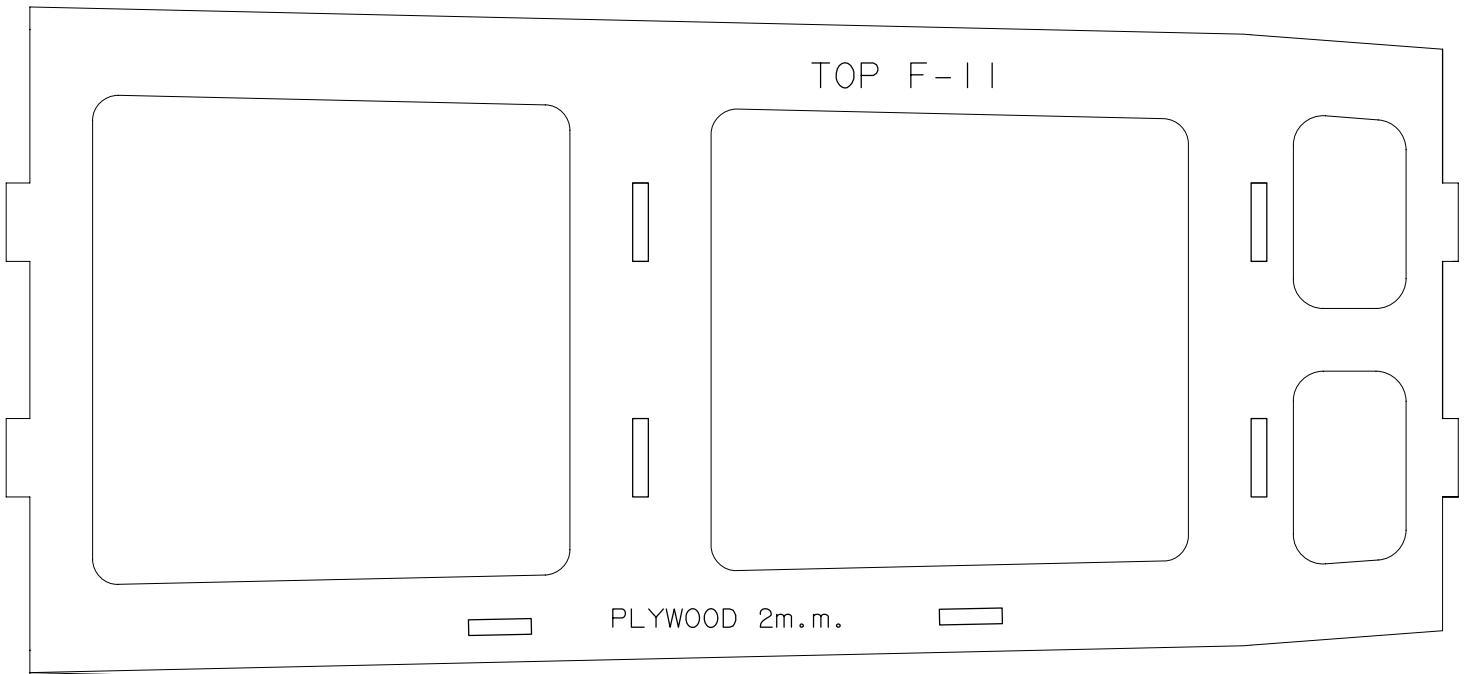
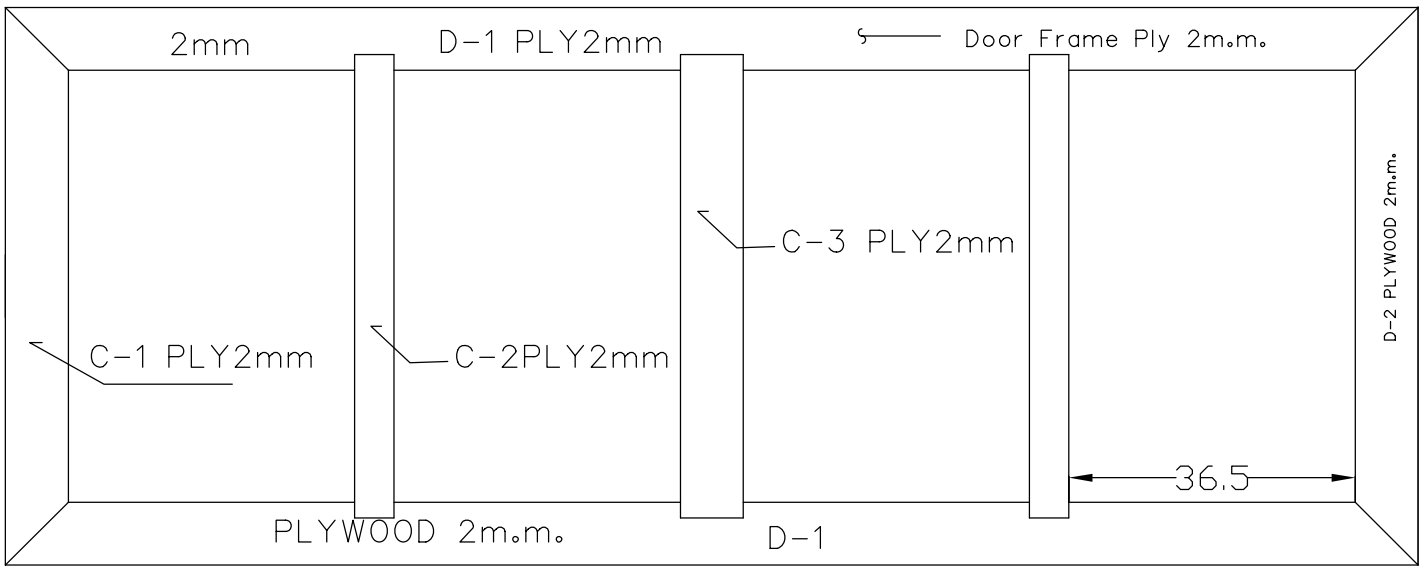

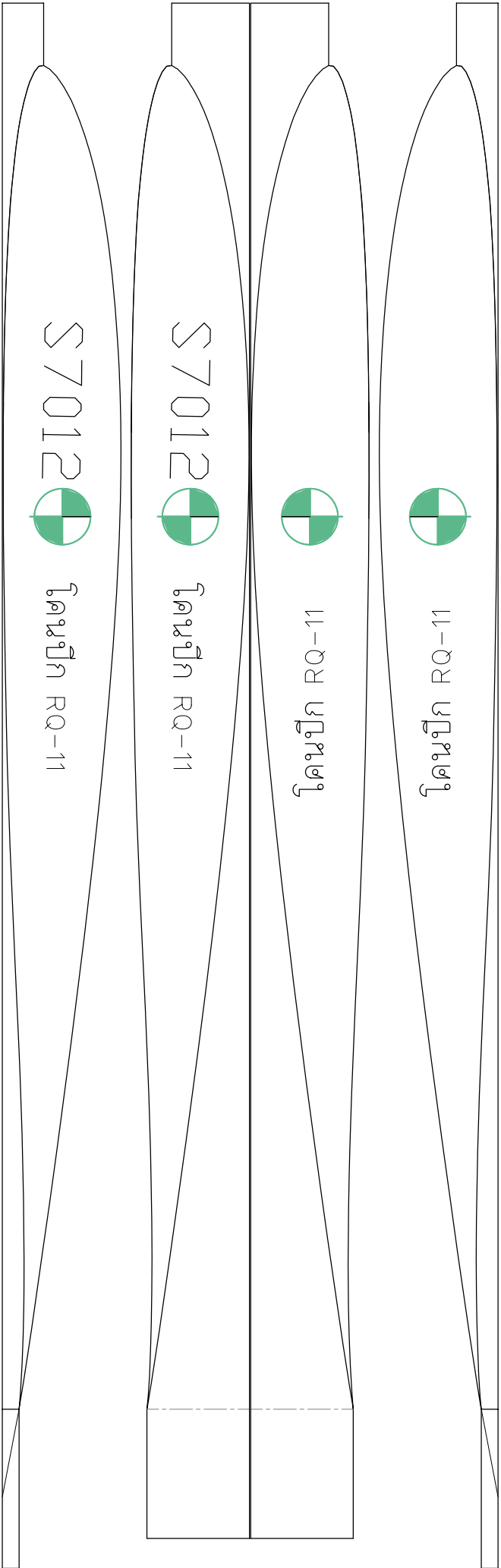
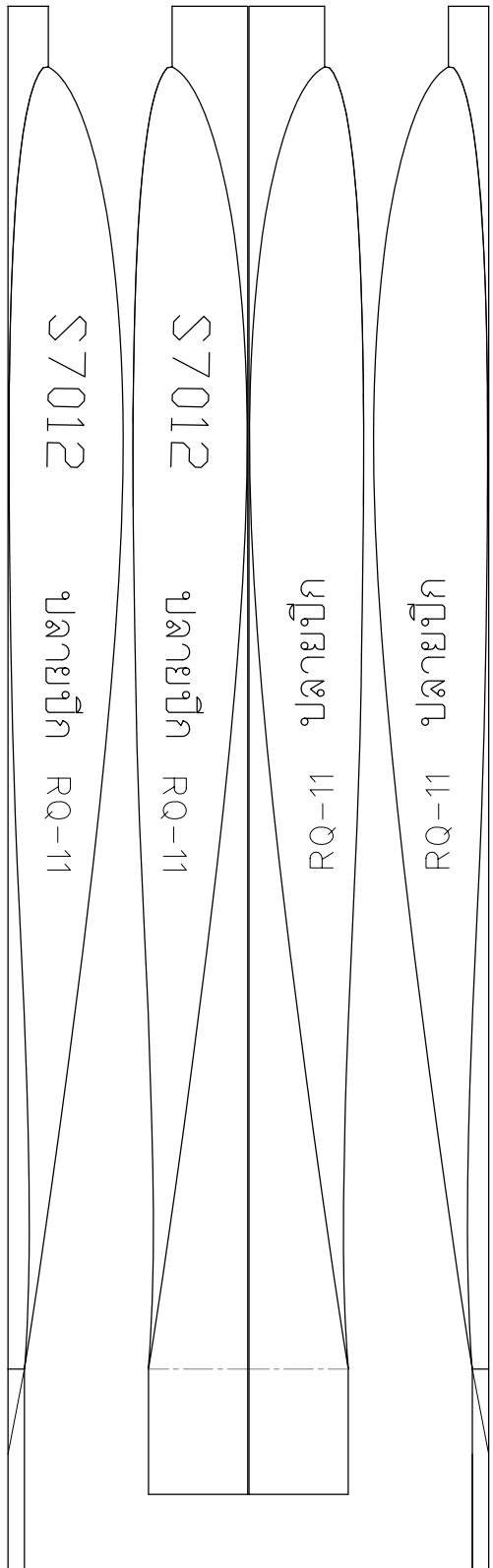

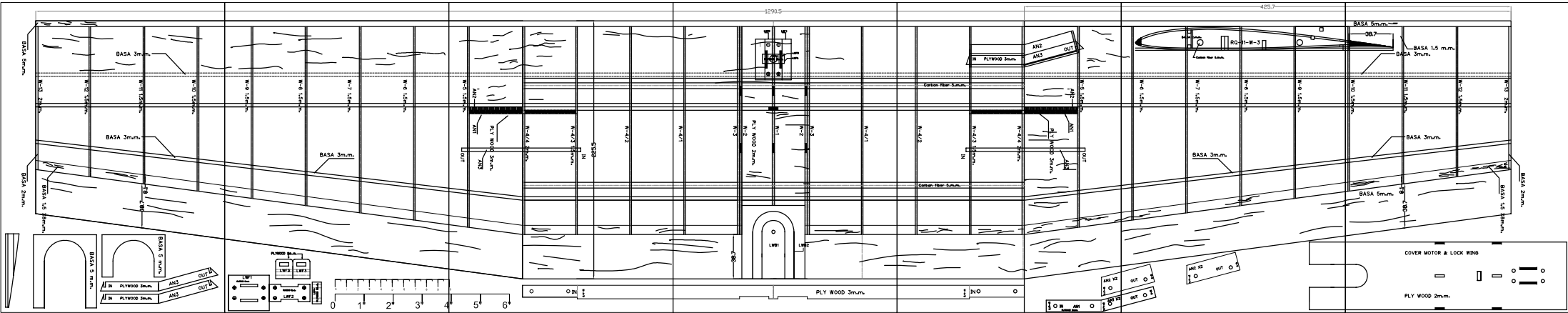

BASA 5m.m.

BASA 3m.m.

W-13 2m.m.

W-12 1.5m.m.

W-11 1.5m.m.

W-10 1.5m.m.

BASA 3m.m.

BASA 2m.m.

BASA 1.5 X 8m.m.

1.8

7.8

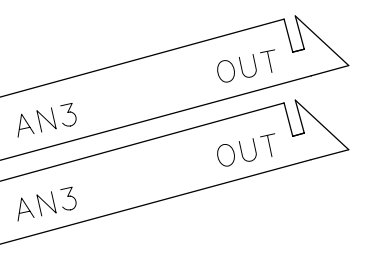
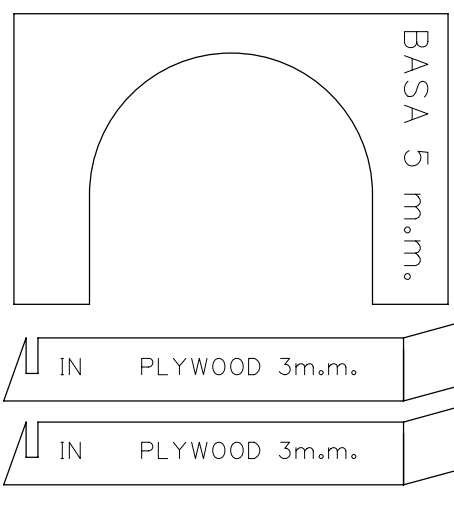
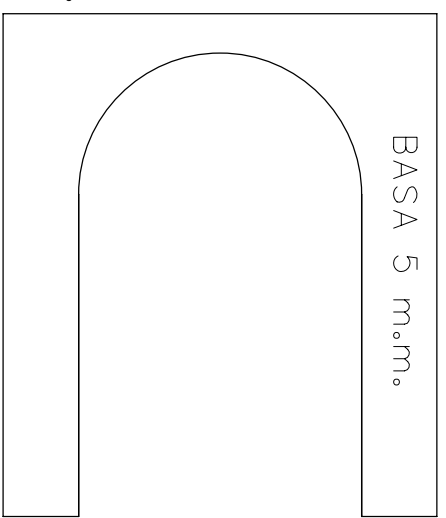

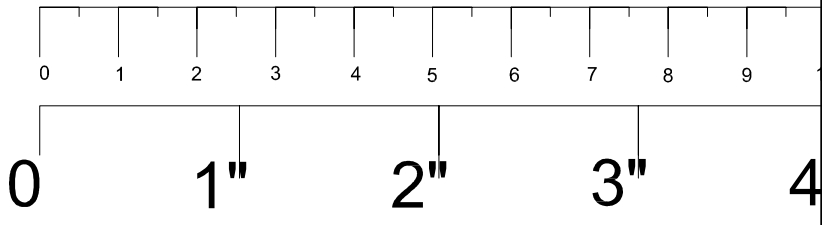
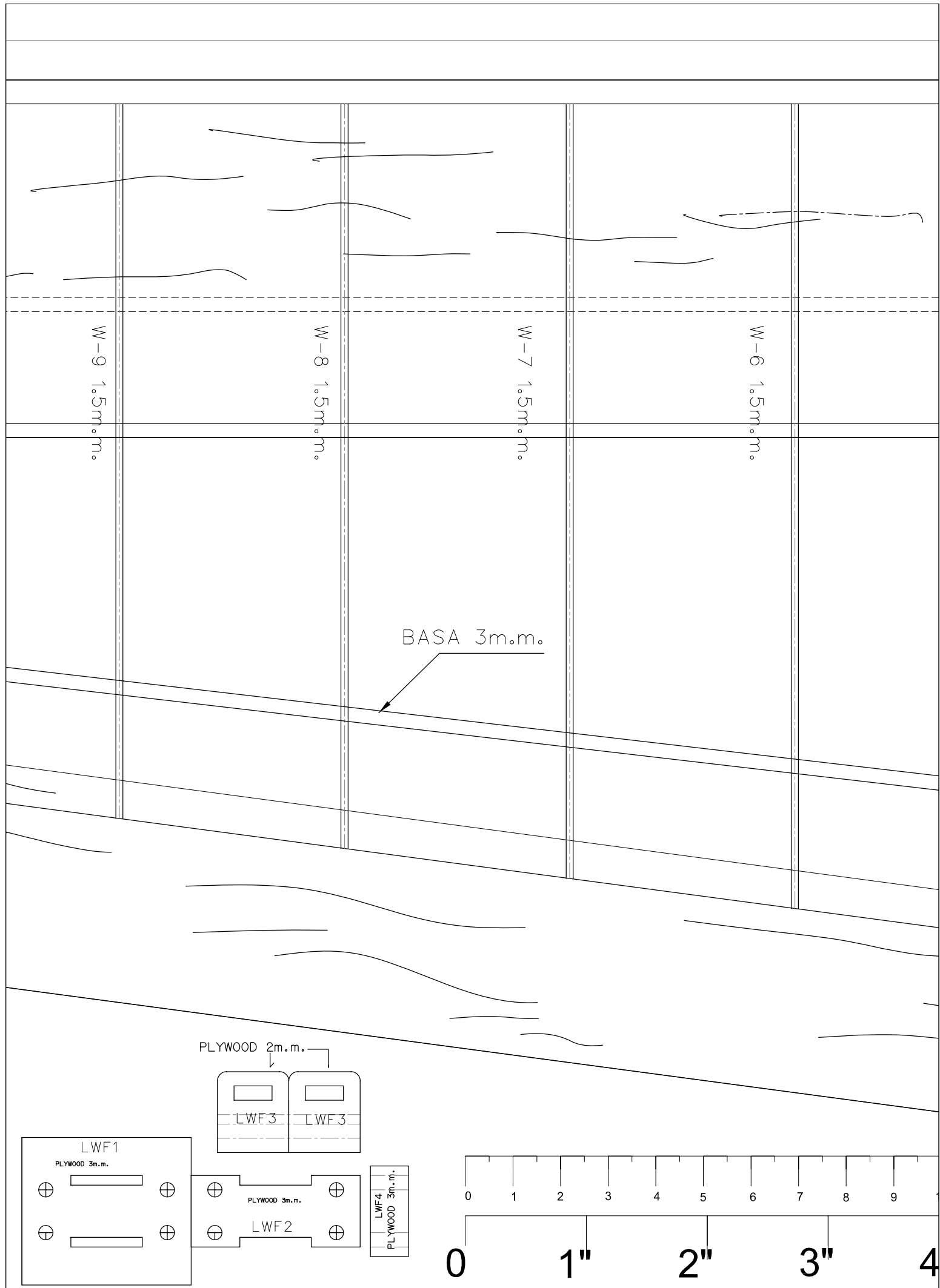

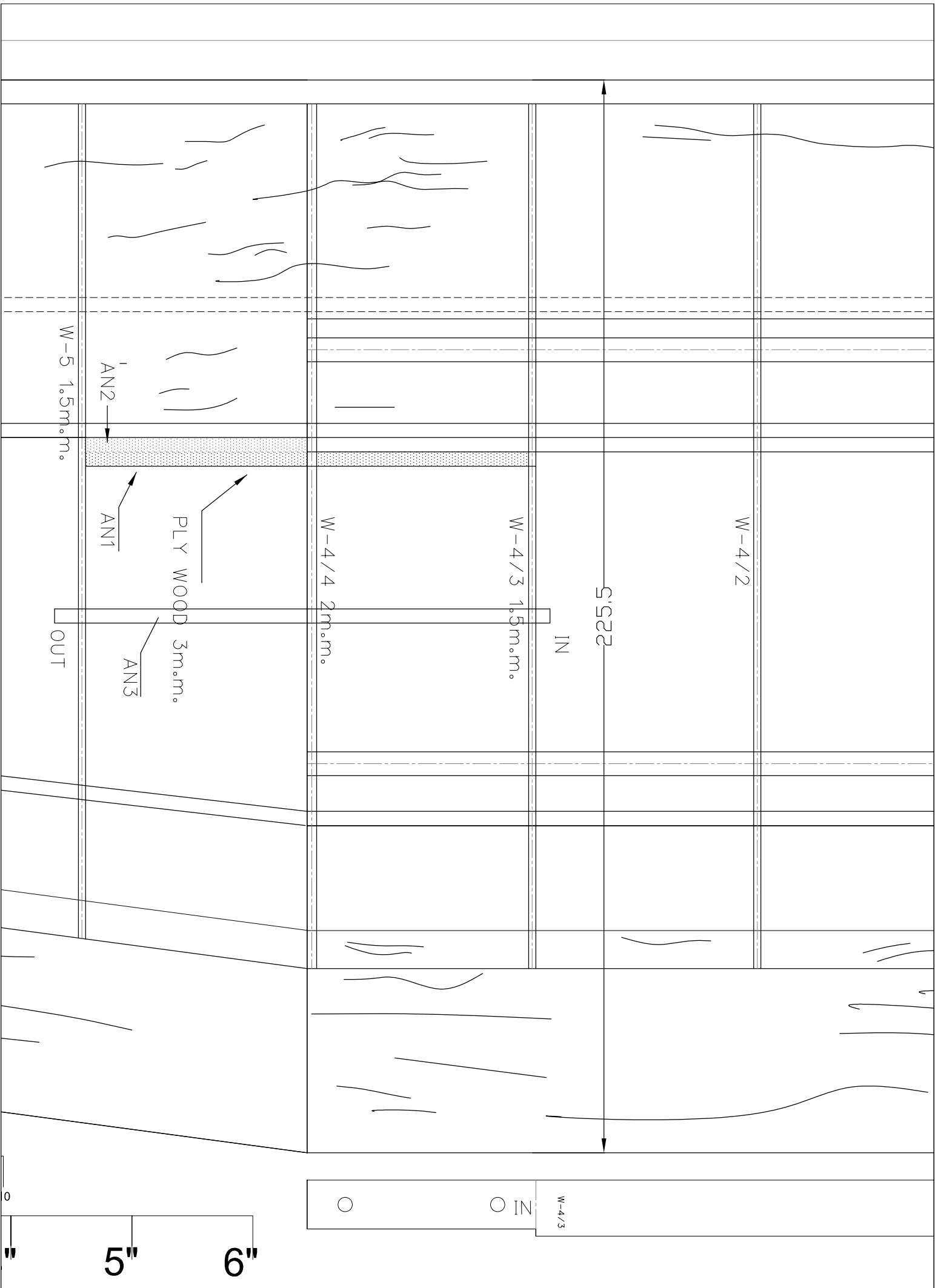

1290.5

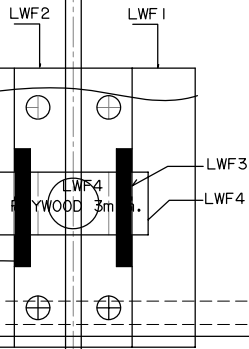

W-4/1

W-3

W-2

PLY WOOD 2m.m.

W-1

W-2

W-3

W-4/1

38.7

LWB1

LWB2

PLY WOOD 3m.m.

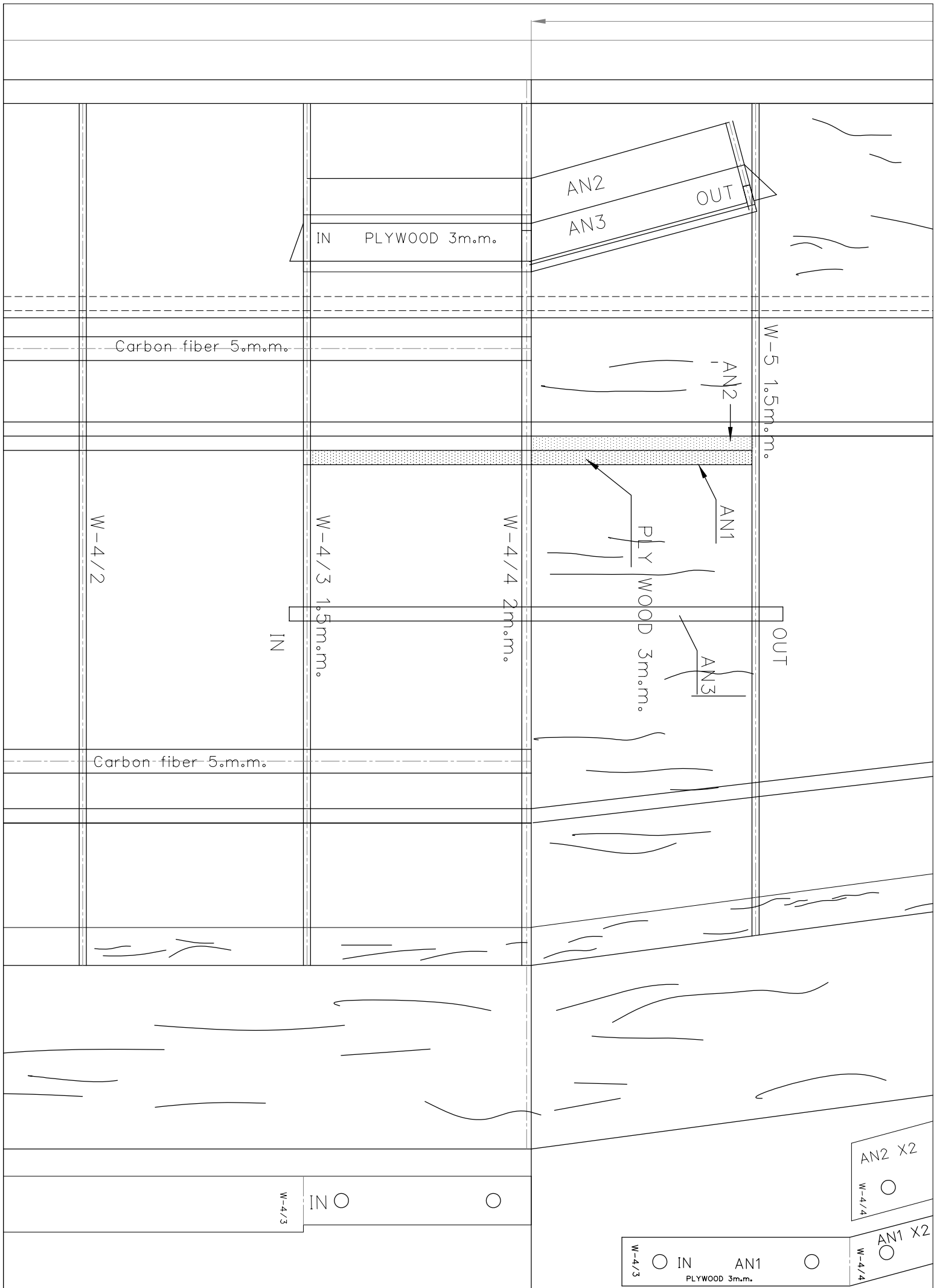

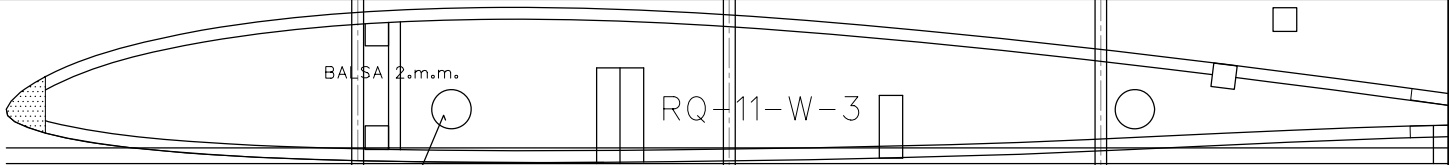

W-6 1.5m.m.

W-7 1.5m.m.

W-8 1.5m.m.

W-9 1.5m.m.

BASA 3m.m.

OUT

W-5

OUT

W-5

AN2 X2

OUT

W-4/4

W-5

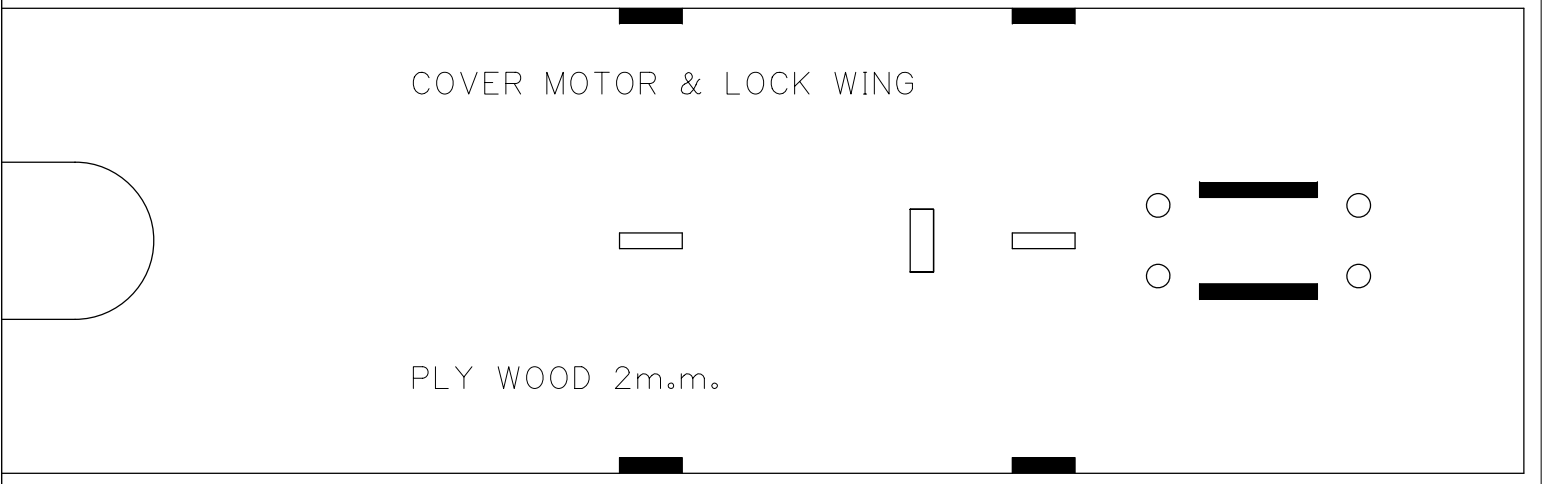
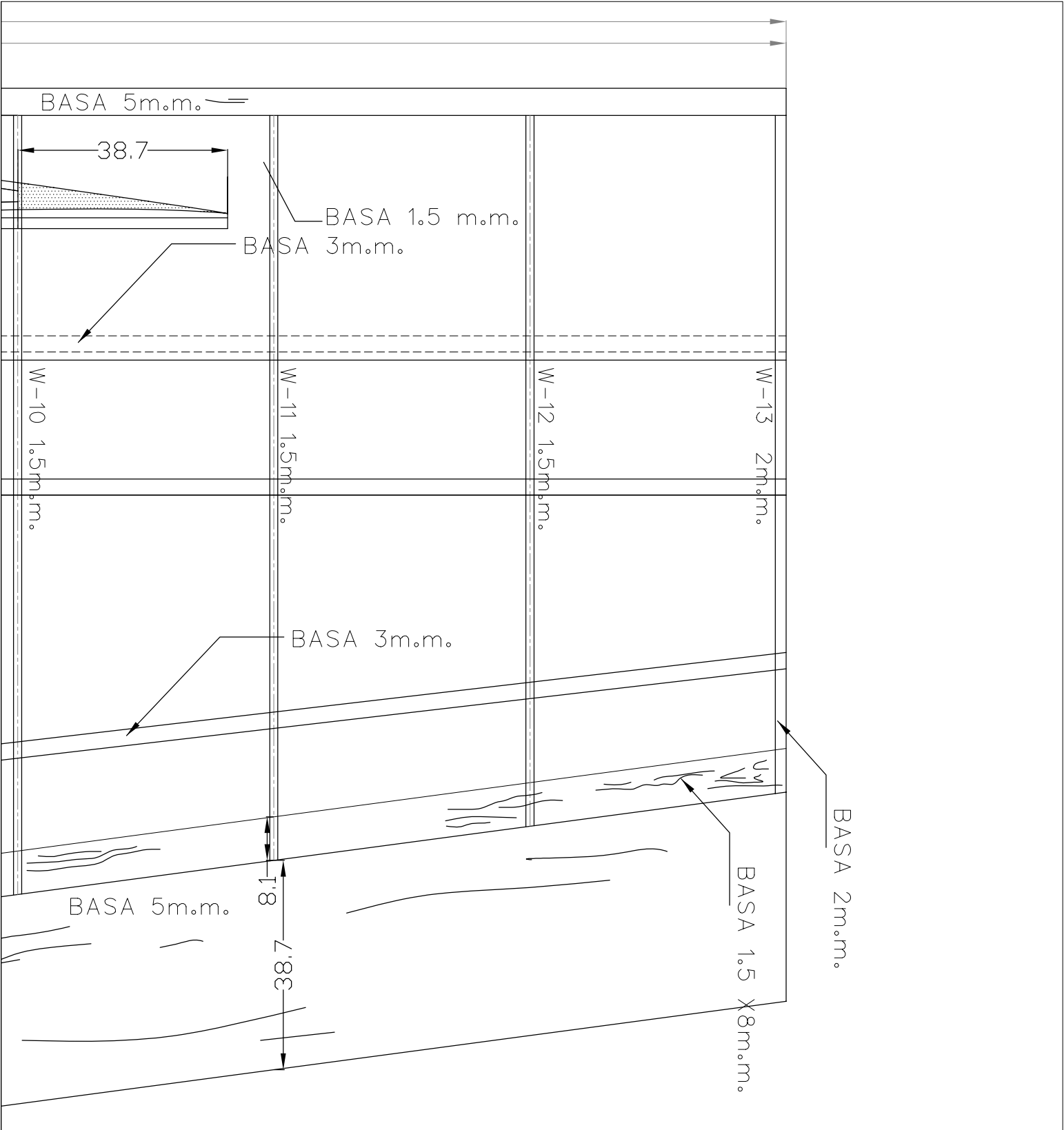

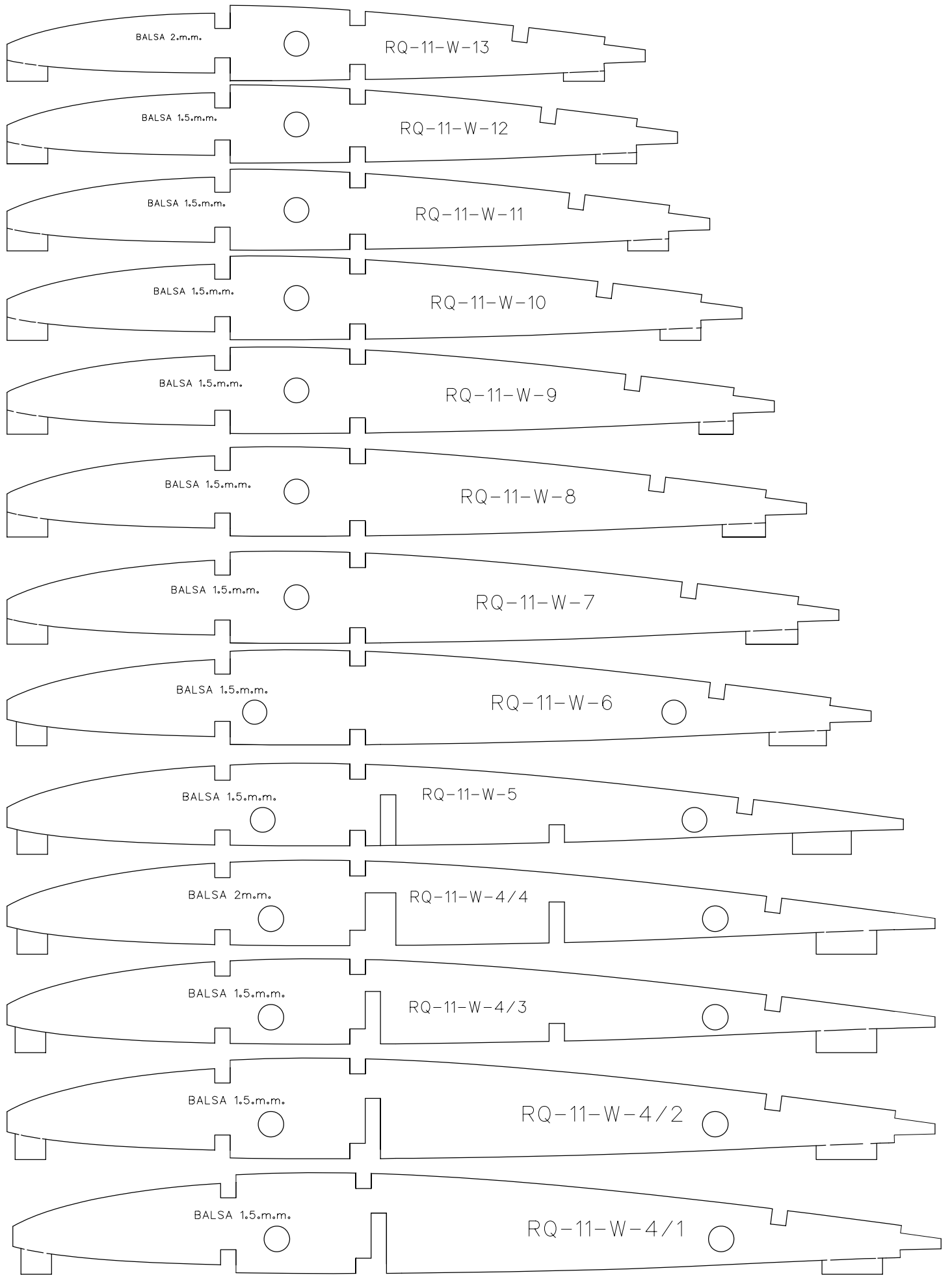

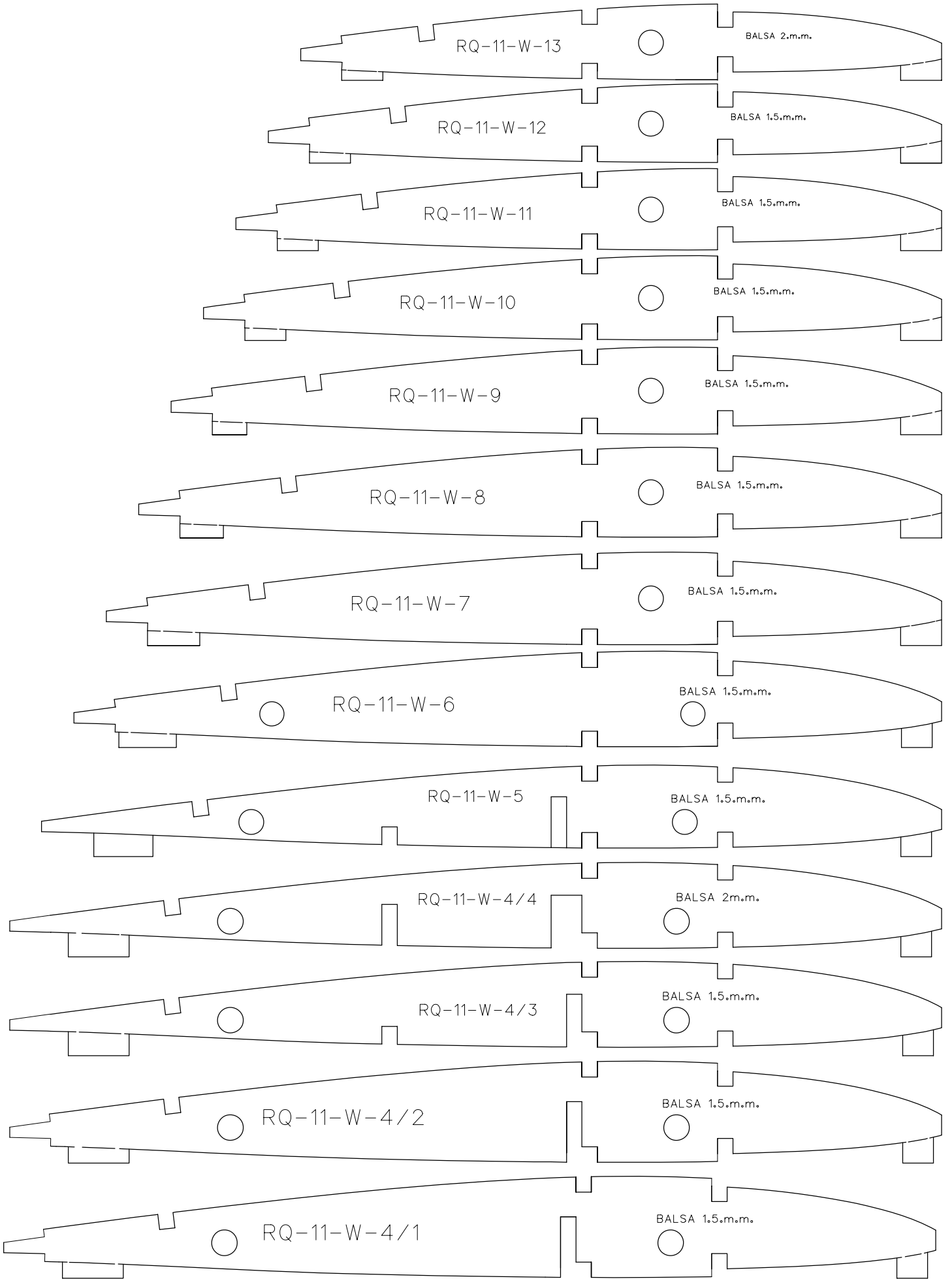

R.C. FLYING Radio Control
THE MOST EXCITING HOBBY & SPORT

RQ-11B RAVEN

FPV THAILAND

WWW.RCTHAI.NET

ช่างามนครชัยค์รี

DESIGNED: Mr.Chalernpol Hamhunsra

เฉลิมพล เทียมทรจรรยา

hs7ei@hotmail.com

WINGSPAN 1290.5m.m.

WING AREA 413.5SQ.IN

LENGTH 1039.4m.m.

POWER MOTOR GS 1350kv SIZE 450

RADIO 3 CHANNEL

WEIGHT 1280g

